

Improving Gear Selectivity in Australian Mud Crab Fisheries

Fishery Report No. 112

M.A. Grubert and H.S. Lee



Australian Government
**Fisheries Research and
Development Corporation**



**Northern Territory
Government**

Project No. 2010/042

Copyright ©:

Northern Territory Government, 2013

This work is copyright. Except as permitted under the Copyright Act 1968 (Commonwealth), no part of this publication may be reproduced by any process, electronic or otherwise, without the specific written permission of the copyright owners. Neither may information be stored electronically in any form whatsoever without such permission.

Disclaimer:

While all care has been taken to ensure that information contained in this Fishery Report is true and correct at the time of publication, changes in circumstances after the time of publication may impact on the accuracy of its information.

The Northern Territory of Australia gives no warranty or assurance, and makes no representation as to the accuracy of any information or advice contained in this Fishery Report, or that it is suitable for your intended use.

You should not rely upon information in this publication for the purpose of making any serious business or investment decisions without obtaining independent and/or professional advice in relation to your particular situation.

The Northern Territory of Australia disclaims any liability or responsibility or duty of care towards any person for loss or damage caused by any use of or reliance on the information contained in this publication.

June 2013

Bibliography:

Grubert, M. A. and Lee, H. S. (2013). Improving Gear Selectivity in Australian Mud Crab Fisheries. Northern Territory Government, Australia. Fishery Report No. 112.

Contact:

Northern Territory Government
Department of Primary Industry and Fisheries
GPO Box 3000
Darwin NT 0801
<http://www.nt.gov.au/d>

Fishery Report No. 112
ISBN: 978-0-7245-4757-9

TABLE OF CONTENTS

List of Tables	iii
List of Figures	vii
Acknowledgements	x
1 NON TECHNICAL SUMMARY	2
2 BACKGROUND.....	4
3 NEED	6
4 OBJECTIVES	6
5 A DESCRIPTION OF SELECTED MORPHOMETRIC RELATIONSHIPS FOR THE GIANT MUD CRAB (<i>Scylla serrata</i>) AND IMPLICATIONS FOR THE SIZING OF ESCAPE VENTS SUITED TO THIS SPECIES	7
5.1 Introduction	7
5.2 Materials and methods.....	7
5.3 Results	9
5.4 Discussion.....	12
6 THE EFFECT OF DIFFERENT NUMBERS OF ESCAPE VENTS ON CATCH RATES OF UNDER-SIZED AND LEGAL-SIZED GIANT MUD CRABS (<i>Scylla serrata</i>) IN WIRE- MESH POTS	13
6.1 Introduction	13
6.2 Materials and methods.....	13
6.2.1 Description of gear	13
6.2.2 Study site and sampling regime	14
6.2.3 Experimental procedures	16
6.2.4 Supplementary data - weight at width relationships for <i>Scylla serrata</i> caught by commercial fishers in the Roper River	17
6.2.5 Data analyses	18
6.3 Results	20
6.3.1 General catch statistics	20
6.3.2 Supplementary data - weight at width relationships for <i>Scylla serrata</i> caught by commercial fishers in the Roper River	22
6.3.3 Analysis of catch rates for control and 46 mm vented wire-mesh pots where the lesser (male) minimum legal size is 140 mm carapace width	22
6.3.4 SELECT modelling of data from wire-mesh pots	25
6.3.5 Gear and bycatch summary	30
6.4 Discussion.....	31
7 THE EFFECT OF ESCAPE VENT SIZE ON CATCH RATES OF UNDER-SIZED AND LEGAL-SIZED GIANT MUD CRABS (<i>Scylla serrata</i>) IN PE-MESH POTS.....	33
7.1 Introduction	33
7.2 Materials and methods.....	33
7.2.1 Description of gear	33
7.2.2 Study sites and sampling regime	35
7.2.3 Experimental procedures	36
7.2.4 Supplementary data - weight at width relationships for <i>Scylla serrata</i> caught by commercial fishers in the Adelaide River	37
7.2.5 Data analyses	37
7.3 Results	37
7.3.1 General catch statistics	37
7.3.2 Supplementary data - weight at width relationships for <i>Scylla serrata</i> caught by commercial fishers in the Adelaide River	40
7.3.3 Catch rates and yield estimates for control and 42 mm vented PE-mesh pots where the lesser (male) minimum legal size is 130 mm carapace width	41
7.3.4 Catch rates and yield estimates for control and 50 mm vented PE-mesh pots where the minimum legal size is 150 mm carapace width	43
7.3.5 SELECT modelling of data from PE-mesh pots	46
7.3.6 Gear and bycatch summary	49
7.4 Discussion.....	50

8	ANALYSES OF RELATED DATA ON THE GIANT MUD CRAB (<i>Scylla serrata</i>) FROM THE NT AND QLD.....	54
8.1	Introduction.....	54
8.2	Materials and methods.....	54
8.2.1	Weight at width relationships for <i>Scylla serrata</i> caught by commercial fishers in all areas of the NT.....	54
8.2.2	Comparisons of catch statistics for <i>Scylla serrata</i> caught in commercial wire-mesh pots set in three NT rivers.....	54
8.2.3	Comparisons of catch statistics for <i>Scylla serrata</i> caught in PE-mesh pots set in different regions of Qld.....	55
8.2.4	Comparisons of catch statistics for <i>Scylla serrata</i> caught in PE-mesh pots set in areas open and closed to fishing in the MBMP.....	56
8.3	Results.....	57
8.3.1	Weight at width relationships for <i>Scylla serrata</i> caught by commercial fishers in all crabbing areas of the NT.....	57
8.3.2	Comparisons of catch statistics for <i>Scylla serrata</i> caught in commercial wire-mesh pots set in three NT rivers.....	58
8.3.3	Comparisons of catch statistics for <i>Scylla serrata</i> caught in PE-mesh pots set in different regions of Qld.....	61
8.3.4	Comparisons of catch statistics for <i>Scylla serrata</i> caught in PE-mesh pots set in areas open and closed to fishing in the MBMP.....	68
8.4	Discussion.....	71
9	POTENTIAL EFFICIENCY GAINS OF FITTING ESCAPE VENTS TO POTS USED BY NT AND QLD MUD CRAB FISHERIES.....	74
9.1	Introduction.....	74
9.2	Materials and methods.....	74
9.3	Results.....	77
9.3.1	NT commercial mud crab fishery.....	77
9.3.2	NT recreational mud crab fishery.....	78
9.3.3	Qld commercial mud crab fishery.....	79
9.3.4	Qld recreational mud crab fishery.....	80
9.4	Discussion.....	81
10	BENEFITS AND ADOPTION.....	82
11	FURTHER DEVELOPMENT.....	86
12	PLANNED OUTCOMES.....	86
13	CONCLUSION.....	86
14	REFERENCES.....	87
15	APPENDIX 1: INTELLECTUAL PROPERTY.....	91
16	APPENDIX 2: STAFF.....	91
17	APPENDIX 3: PARAMETER ESTIMATES AND CORRELATION COEFFICIENTS (ADJUSTED r^2) FOR GAUSSIAN CURVES FITTED TO RELATIVE SIZE FREQUENCY DATA.....	92
18	APPENDIX 4: SUMMARY OF THE SAMPLING TIMETABLE FOR THE MUD CRAB DEPLETION AND TRAPPING WEB SURVEYS ON THE ADELAIDE AND WEARYAN RIVERS, NT.....	93
19	APPENDIX 5: SUMMARY OF THE SAMPLING TIMETABLE FOR THE MUD CRAB COMPONENT OF THE QLD LTMP.....	94
20	APPENDIX 6: SUMMARY OF THE SAMPLING TIMETABLE FOR THE MORETON BAY MONITORING PROGRAM.....	96
21	APPENDIX 7: DERIVATION OF CATCH STATISTICS FOR THE NT RECREATIONAL MUD CRAB FISHERY.....	97
22	APPENDIX 8: SCHEMATICS FOR PLASTIC INJECTION MOULDED ESCAPE VENTS.....	98
23	APPENDIX 9: PRESENTATIONS AND RELATED MEDIA.....	99

LIST OF TABLES

Table 2.1. Minimum legal sizes (MLSs; mm) applied to <i>Scylla serrata</i> within its Australian range. Expressed as carapace width (CW) except in NSW where carapace length (CL) is used. *85 mm CL approximates 125 mm CW for NSW crabs (Paul Butcher, pers. comm.). **Recreational fishers in WA are not permitted to use pots and the commercial mud crab fishery (which can use pots) is comparatively small (~5 tonnes per annum; Danielle Johnstone, WA Fisheries, pers. comm.).	5
Table 5.1. Upper and lower estimates of carapace height (escape vent height) and total length (escape vent width) for minimum legal sizes of 130 mm, 140 mm and 150 mm carapace width (CW) (based on the equations for the dashed boundary lines in Figure 5.2) for <i>Scylla serrata</i> . The dimensions in bold were adopted for the prototype escape vents suited to retain crabs ≥ 140 mm CW.	10
Table 5.2. Upper and lower estimates of carapace height (escape vent height) and total length (escape vent width) for an minimum legal size of 85 mm carapace length (based on the equations for the dashed boundary lines in Figure 5.3) for <i>Scylla serrata</i> .	11
Table 5.3. Revised upper and lower estimates of carapace height (escape vent height) and total length (escape vent width) for minimum legal sizes of 130 mm, 140 mm and 150 mm carapace width for <i>Scylla serrata</i> .	12
Table 6.1. Sampling dates, minimum and maximum predicted daily tidal amplitude (TA) for each trip to the Roper River.	16
Table 6.2. Fishing effort (pot-lifts), total catch, unique catch (excluding recaptures, dead or parasitised animals), effective effort (number of pot-lifts that caught one or more unique crabs) and significance tests for catch by sex (based on unique catch) of <i>Scylla serrata</i> sampled from the Roper River relative to experimental group. Chi-squared (χ^2) values calculated using one degree of freedom.	20
Table 6.3. Fishing effort (pot-lifts), total catch, unique catch (excluding recaptures, dead or parasitised animals), effective effort (number of pot-lifts that caught one or more unique crabs) and significance tests for catch by sex (based on unique catch) of <i>Scylla serrata</i> sampled from the Roper River relative to season. Chi-squared (χ^2) values calculated using one degree of freedom.	21
Table 6.4. Catch, mean size, total estimated weight and catch rate statistics for unique male (σ) and female (ρ) <i>Scylla serrata</i> in different size categories (reflecting current minimum legal sizes for the NT commercial fishery) caught in vented and unvented (control) wire-mesh pots set in the Roper River. See Table 6.2 for the number of pot-lifts per group. Threshold significance level = 0.0083 (Bonferroni p -value for 6 individual tests at 5% level).	24
Table 6.5. Results of SELECT modelling on the catch of <i>Scylla serrata</i> (sexes pooled) in wire-mesh pots fitted with different numbers and configurations of 46 mm escape vents. The Akaike's Information Criterion (AIC) value was used to rank the different models in order of the most parsimonious fit.	26
Table 6.6. Results of SELECT modelling on the catch of male <i>Scylla serrata</i> in wire-mesh pots fitted with different numbers and configurations of 46 mm escape vents. The Akaike's Information Criterion (AIC) value was used to rank the different models in order of the most parsimonious fit.	27
Table 6.7. Results of SELECT modelling on the catch of female <i>Scylla serrata</i> in wire-mesh pots fitted with different numbers and configurations of 46 mm escape vents. The Akaike's Information Criterion (AIC) value was used to rank the different models in order of the most parsimonious fit.	28
Table 6.8. Mean incidence of bycatch in pots with different numbers of 46 mm escape vents. Data for the three groups of pots with two escape vents (in different orientations) were pooled. Figures below treatment names refer to the number of pot-lifts for that treatment where bycatch records were taken. Dash indicates species not recorded. An asterisk (*) indicates only one observation per group.	30
Table 7.1. Sampling dates, minimum and maximum predicted daily tidal amplitude (TA) for each trip to the Adelaide River.	35

- Table 7.2.** Fishing effort (pot-lifts), total catch (of *Scylla* spp.), unique catch (excluding *S. olivacea*, recaptures, dead or parasitised animals), effective effort (number of pot-lifts that caught one or more unique crabs) and significance tests for catch by sex (based on unique catch) of *S. serrata* relative to river system and experimental group. Chi-squared (χ^2) values calculated using one degree of freedom. The catch of unique males and females in control and 2x42mm treatment pots set in the Adelaide River were identical. 37
- Table 7.3.** Fishing effort (pot-lifts), total catch (of *Scylla* spp.), unique catch (excluding *S. olivacea*, recaptures, dead or parasitised animals), effective effort (number of pot-lifts that caught one or more unique crabs) and significance tests for catch by sex (based on unique catch) of *S. serrata* relative to river system and season. Chi-squared (χ^2) values calculated using one degree of freedom. 38
- Table 7.4.** Catch, mean size, total estimated weight and catch rate statistics for unique male (σ) and female (ρ) *Scylla serrata* in different size categories (reflecting current minimum legal sizes for the NT recreational fishery) caught in vented and unvented (control) polyethylene-mesh pots set in the Adelaide River. See Table 7.2 for the number of pot-lifts per group. Threshold significance level = 0.05. 42
- Table 7.5.** Catch, mean size, total estimated weight and catch rate statistics for unique male (σ) and female (ρ) *Scylla serrata* in different size categories (reflecting current minimum legal sizes for the NT recreational fishery) caught in vented and unvented (control) polyethylene-mesh pots set in the Roper River. See Table 7.2 for the number of pot-lifts per group. Threshold significance level = 0.05. 43
- Table 7.6.** Catch, mean size, total estimated weight and catch rate statistics for unique male (σ) and female (ρ) *Scylla serrata* in different size categories (reflecting current male and hypothetical female minimum legal sizes for the Qld fishery) caught in vented and unvented (control) polyethylene-mesh pots set in the Adelaide River. See Table 7.2 for the number of pot-lifts per group. Threshold significance level = 0.05. 45
- Table 7.7.** Significant differences (at 10% and 5% levels) in catch rates between control and 2x50mm pots (set in the Adelaide River) and the direction of change relative to sex/size category and season 45
- Table 7.8.** Catch, mean size, total estimated weight and catch rate statistics for unique male (σ) and female (ρ) *Scylla serrata* in different size categories (reflecting current male and hypothetical female minimum legal sizes for the Qld fishery) caught in vented and unvented (control) polyethylene-mesh pots set in the Roper River. See Table 7.2 for the number of pot-lifts per group. Threshold significance level = 0.05. 46
- Table 7.9.** Results of SELECT modelling of 2x42mm vented polyethylene-mesh pots set in the Adelaide River. The Akaike's Information Criterion (AIC) value was used to rank the different models in order of the most parsimonious fit. 47
- Table 7.10.** Results of SELECT modelling of 2x50mm vented polyethylene-mesh pots set in the Adelaide River. The Akaike's Information Criterion (AIC) value was used to rank the different models in order of the most parsimonious fit. 47
- Table 7.11.** Results of SELECT modelling of 2x42mm and 2x50mm vented polyethylene-mesh pots set in the Roper River. The Akaike's Information Criterion (AIC) value was used to rank the different models in order of the most parsimonious fit. 49
- Table 7.12.** Mean incidence of bycatch species in polyethylene-mesh pots (pooled across rivers) with and without escape vents (EV) of different sizes. Figures below treatment names refer to the number of pot-lifts for that treatment where bycatch records were taken. Dash indicates species not recorded. An asterisk (*) indicates only one observation per treatment. 51
- Table 8.1.** Summary statistics for *Scylla serrata* caught in unvented commercial wire mesh pots set in the Wearyan and Adelaide rivers in 2002-03 and the Roper River in 2010-11. Minimum legal sizes (MLSs) are 140 mm carapace width (CW) for males (σ) and 150 mm CW for females (ρ). Values in parentheses are sample sizes. 59
- Table 8.2.** Summary statistics for *Scylla serrata* caught in polyethylene-mesh pots set in the Gulf of Carpentaria (GOC), far north (FN), northern wet (NW), northern dry (ND), Capricorn (CAP), Fraser-Burnett (FB) and Moreton Bay (MOR) regions of Qld (where the minimum legal size [MLS] = 150 mm carapace width [CW] for males, noting that female crabs below this size will also use escape vents). ALL = all regions combined. Values in parentheses are sample sizes. 62

Table 8.3. Summary of catch statistics for <i>Scylla serrata</i> caught in polyethylene-mesh pots set in areas open (general use zone) and closed to fishing (new and old green zones) in the Moreton Bay Marine Park, Qld (where the minimum legal sizes [MLS] = 150 mm carapace width [CW] for males, noting that female crabs below this size will also use escape vents). Values in parentheses are sample sizes.	69
Table 8.4. Coefficients, exponents and sample sizes (<i>n</i>) for weight at width relationships for male (♂) and female (♀) <i>Scylla serrata</i> caught by commercial fishers in the Adelaide and Roper rivers and all sampling areas of the NT pooled	72
Table 9.1. Mean carapace width (CW) (mm) and corresponding estimated wet weight (WW) (kg) of under-sized and legal-sized male (♂) and female (♀) <i>Scylla serrata</i> caught in unvented wire-mesh pots and unvented polyethylene-mesh pots set in the NT and Qld, respectively. Values in bold are referred to in Tables 9.6 to 9.9.	75
Table 9.2. Harvest fractions of <i>Scylla serrata</i> caught in unvented pots set in the NT and Qld. Values in bold are referred to in Tables 9.6 and 9.8.	75
Table 9.3. Estimates of the catch rate of under-sized crabs in treatment pots relative to that in control pots (the catch relative to control [CRC]) for three different escape vent (EV) sizes (suited to the NT recreational, NT commercial and Qld mud crab fisheries from left to right, respectively). All treatments used two escape vents per pot. Values in bold are referred to in Tables 9.6 to 9.9.	76
Table 9.4. Mean carapace width (CW) and corresponding estimated wet weight (WW) of under-sized and legal-sized <i>Scylla serrata</i> (as per the minimum legal sizes for the NT recreational fishery) caught in unvented, polyethylene-mesh pots set in the Adelaide River. The value in bold is referred to in Table 9.7.	76
Table 9.5. Estimates of the catch rate of legal-sized crabs in treatment pots relative to that in control pots (the catch relative to control [CRC]) for three different escape vent (EV) sizes (suited to the NT recreational, NT commercial and Qld mud crab fisheries from left to right, respectively). All treatments used two escape vents per pot.	77
Table 9.6. Potential efficiency gains (in terms of the difference in handling of under-sized crabs) of fitting two, 110 mm x 46 mm (W x H) escape vents to wire-mesh pots (mesh size 75 mm x 50 mm) when the annual commercial harvest is 400 tonnes. Minimum legal sizes in this example are 140 mm carapace width (CW) for males and 150 mm CW for females. The abbreviations U/S and L/S refer to under-sized and legal-sized crabs, respectively. Numbers and weights of crabs are rounded to the nearest multiple of 100.	78
Table 9.7. Potential efficiency gains (in terms of the difference in handling of under-sized [U/S] crabs) of fitting two, 120 x 42 mm escape vents (W x H) to polyethylene-mesh pots (mesh size 25 mm x 25 mm) when the annual recreational catch is 85 000 crabs. Minimum legal sizes in this example are 130 mm carapace width (CW) for males and 140 mm CW for females. Numbers and weights of crabs are rounded to the nearest multiple of 100.	79
Table 9.8. Potential efficiency gains (in terms of the difference in handling of under-sized crabs) of fitting two, 120 x 50-mm escape (W x H) vents to polyethylene-mesh pots (mesh size 50 mm x 50 mm) when the annual commercial harvest of males is 1000 t. The minimum legal size in this example is 150 mm carapace width (CW). The abbreviations U/S and L/S refer to under-sized and legal-sized crabs, respectively. The term “U/S females” is used as females <150 mm CW also use escape vents. Numbers and weights of crabs are rounded to the nearest multiple of 100.	80
Table 9.9. Potential efficiency gains (in terms of the difference in handling of under-sized [U/S] crabs) of fitting two, 120 mm x 50 mm (W x H) escape vents to polyethylene-mesh pots (mesh size 50 mm x 50 mm) when the annual recreational catch of males is 2 763 000 individuals. The minimum legal size in this example is 150 mm carapace width. Numbers and weights of crabs are rounded to the nearest multiple of 100.	80
Table 10.1. Names and locations of commercial mud crab fishers who tested (laser cut) prototype escape vents supplied by DPIF	83
Table 16.1. Project staff and affiliations	91
Table 18.1. Sampling intervals and sample sizes for mud crab depletion and trapping web surveys on the Adelaide and Wearyan rivers, NT. The term “unique crabs” refers to live, unparasitised, previously untagged <i>Scylla serrata</i> caught in 70 mm x 50 mm wire mesh pots.	93

Table 19.1. Sampling effort (as days within each sampling period and year) and sample sizes for *Scylla serrata* caught during monitoring trips to the Gulf of Carpentaria (GOC), far north, northern wet and northern dry regions of Qld 94

Table 19.2. Sampling effort (as days within each sampling period and year) and sample sizes for *Scylla serrata* caught during monitoring trips to the Capricorn, Fraser-Burnett and Moreton Bay regions of Qld 95

Table 20.1. Sampling effort (as days within each year and season) and sample sizes for *Scylla serrata* caught in areas open and closed to fishing (general use and green zones, respectively) in the Moreton Bay Monitoring Program, Qld..... 96

Table 21.1. Recreational catch, harvest and release statistics for mud crabs in the NT relative to fisher origin and survey type (derived from West et al., 2012) 97

LIST OF FIGURES

Figure 2.1. Commercially harvested Giant Mud Crabs (<i>Scylla serrata</i>) tied and ready for market.....	4
Figure 2.2. Two styles of collapsible polyethylene-mesh pots. The rectangular pot folds and locks in the centre of the longest axis (similar to a purse). The circular pot is held open by four grooved PVC uprights that, when disengaged from the top hoop, allow the pot to fold flat.	5
Figure 2.3. A wire-mesh pot with two funnels and central bait box. The upper and lower rubber straps hold closed the doors to the main chamber and bait box, respectively.....	5
Figure 5.1. Location of sampling/fisher feedback sites in the Northern Territory (NT).....	8
Figure 5.2. Plots of a) carapace height and b) total length versus carapace width for the Giant Mud Crab (<i>Scylla serrata</i>). The dashed lines which bound the data in each plot have the same slopes, but different intercepts (± 4 mm in a; ± 6 mm in b) as the corresponding regression equations.....	10
Figure 5.3. Plots of a) carapace height and b) total length versus carapace length for the Giant Mud Crab (<i>Scylla serrata</i>). The dashed lines which bound the data in each plot have the same slopes, but different intercepts (± 4 mm) as the corresponding regression equations.....	11
Figure 6.1. A wire-mesh pot with four escape vents fitted.....	14
Figure 6.2. Location of the Roper River, Northern Territory (NT).....	15
Figure 6.3. Position of moult index test sites on male (left) and female (right) <i>Scylla serrata</i>	17
Figure 6.4. Relative size frequency of unique male a) and female b) <i>Scylla serrata</i> caught in wire-mesh pots set in the Roper River. Upper bin values for each 5-mm size category end with 4 or 9. Parameter values and correlations coefficients for Gaussian curves are given in Appendix 3...21	21
Figure 6.5. Relationships between carapace width and wet weight for a) male and b) female <i>Scylla serrata</i> sampled from the catch of commercial fishers operating in the Roper River	22
Figure 6.6. Logistic selectivity curves for <i>Scylla serrata</i> (pooled across sex) caught in wire-mesh pots fitted with different numbers and configurations of 46 mm escape vents. The horizontal dotted line intersects the length at 50% retention (L_{50}) for each curve. The vertical line represents the minimum legal size for male <i>S. serrata</i> harvested by the NT commercial mud crab fishery.....	29
Figure 6.7. Logistic selectivity curves for male <i>Scylla serrata</i> caught in wire-mesh pots fitted with different numbers and configurations of 46 mm escape vents. The horizontal dotted line intersects the length at 50% retention (L_{50}) for each curve. The vertical line represents the minimum legal size for male <i>S. serrata</i> harvested by the NT commercial mud crab fishery.....	29
Figure 6.8. Logistic selectivity curves for female <i>Scylla serrata</i> caught in wire-mesh pots fitted with different numbers and configurations of 46 mm escape vents. The horizontal dotted line intersects the length at 50% retention (L_{50}) for each curve. The vertical line represents the minimum legal size for female <i>S. serrata</i> harvested by the NT commercial mud crab fishery.	30
Figure 7.1. A polyethylene-mesh pot with escape vent (bottom right) fitted perpendicular to funnel (left of centre). A white plastic panel obscures the rear of the pot and was inserted to highlight design features only.....	34
Figure 7.2. Close up of a dual sized escape vent fitted to polyethylene-mesh pots	34
Figure 7.3. Location of the Adelaide River, Northern Territory (NT)	36
Figure 7.4 Relative size frequency of unique a) male and b) female <i>Scylla serrata</i> caught in polyethylene-mesh pots set in the Adelaide River. Upper bin values for each 5-mm size category end with 4 or 9. Parameter values and correlation coefficients for Gaussian curves given in Appendix 3...39	39
Figure 7.5 Relative size frequency of unique a) male and b) female <i>Scylla serrata</i> caught in polyethylene-mesh pots set in the Roper River. Upper bin values for each 5-mm size category end with 4 or 9. Parameter values and correlation coefficients for Gaussian curves are given in Appendix 3.40	40
Figure 7.6. Relationships between carapace width and wet weight for a) male and b) female <i>Scylla serrata</i> sampled from the catch of commercial fishers operating in the Adelaide River.....	41

- Figure 7.7.** Pooled and sex-specific selectivity curves (Richards' functions with estimated p) for *Scylla serrata* caught in 2x42mm (red lines) and 2x50mm (blue lines) vented polyethylene-mesh pots set in the Adelaide River. The horizontal dotted line intersects the length at 50% retention (L_{50}) for each curve. The left and right vertical lines represent the minimum legal sizes for males harvested by the NT recreational fishery and the Qld mud crab fishery, respectively..... 48
- Figure 7.8.** Selectivity curves (logistic functions with equal p - pooled across sex) for *Scylla serrata* caught in 2x42mm and 2x50mm vented polyethylene-mesh pots set in Roper River (RR; red lines) and Adelaide River (AR; blue lines). The horizontal dotted line intersects the length at 50% retention (L_{50}) for each curve. The left and right vertical lines represent the minimum legal sizes for males harvested by the NT recreational fishery and the Qld mud crab fishery, respectively..... 49
- Figure 8.1.** Distribution of mud crab sampling sites in Qld (from Jebreen et al., 2008; with permission)..... 55
- Figure 8.2.** Distribution of crab sampling sites within the Moreton Bay Marine Park (MBMP), Qld. Points bound by red lines indicate sampling in areas open to fishing. The Tripcony Bight (02) and Willes Island (MNP29) sites represent old green zones. All other sites sampled (including those bound by purple lines) were in "new green zones". Image courtesy of Richard Pillans, CSIRO.57
- Figure 8.3.** Relationships between carapace width and wet weight for a) male and b) female *Scylla serrata* sampled from the catch of commercial fishers operating in all crabbing areas of the NT 58
- Figure 8.4.** Relative size frequencies of male (left) and female (right) *Scylla serrata* caught in unvented commercial wire-mesh pots set in the Wearyan (a,b) and the Adelaide rivers (c,d) in 2002-03 and the Roper River (e,f) in 2010-11. Upper bin values for each 5-mm size category end with 4 or 9. Parameter values and correlation coefficients for Gaussian curves given in Appendix 3. . 60
- Figure 8.5.** Cumulative size frequency of *Scylla serrata* caught in unvented commercial wire-mesh pots set in the Wearyan River (WR) and Adelaide River (AR) in 2002-03 and the Roper River (RR) in 2010-11. Plots a) and b) show data for males and females, respectively. Plot c) shows data for both sexes combined. Upper bin values for each 5-mm size category end with 4 or 9. The left and right dotted vertical lines show minimum legal sizes for male and female *S. serrata* harvested by the NT commercial mud crab fishery, respectively. 61
- Figure 8.6.** Relative size frequency of male (left) and female (right) *Scylla serrata* caught in polyethylene-mesh pots set in the Gulf of Carpentaria (a,b), the far north (c,d), the northern wet (e,f) and the northern dry (g,h) regions of Qld. Upper bin values for each 5-mm size category end with 4 or 9. Parameter values and correlation coefficients for Gaussian curves given in Appendix 3. 64
- Figure 8.7.** Relative size frequency of male (left) and female (right) *Scylla serrata* caught in polyethylene-mesh pots set in the Capricorn (a,b), Fraser-Burnett (c,d) and Moreton Bay (e,f) regions of Qld. Upper bin values for each 5-mm size category end with 4 or 9. Parameter values and correlation coefficients for Gaussian curves given in Appendix 3..... 65
- Figure 8.8** Cumulative size frequency of *Scylla serrata* caught in polyethylene-mesh pots set in the Gulf of Carpentaria (GOC), far north (FN), northern wet (NW), northern dry (ND), Capricorn (CAP), Fraser-Burnett (FB) and Moreton Bay (MOR) regions of Qld. Plots a) and b) show data (pooled across sex) for northern and southern regions, respectively. Plot c) shows pooled and sex specific data for all areas combined. Upper bin values for each 5 mm size category end with 4 or 9. The dotted vertical line shows the minimum legal size for males harvested by the Qld mud crab fishery..... 66
- Figure 8.9.** Pooled and sex-specific cumulative size frequency of *Scylla serrata* caught in polyethylene-mesh pots set in a) the Gulf of Carpentaria, b) the far north, c) the northern wet and d) northern dry regions of Qld. Upper bin values for each 5-mm size category end with 4 or 9. The dotted vertical line shows the minimum legal size for males harvested by the Qld mud crab fishery. .. 67
- Figure 8.10.** Pooled and sex-specific cumulative size frequency of *Scylla serrata* caught in polyethylene-mesh pots set in a) the Capricorn, b) the Fraser-Burnett and c) the Moreton Bay regions of Qld. Upper bin values for each 5-mm size category end with 4 or 9. The dotted vertical line shows the minimum legal size for males harvested by the Qld mud crab fishery..... 68
- Figure 8.11.** Relative size frequencies of male (left) and female (right) *Scylla serrata* caught in polyethylene-mesh pots set in areas of the Moreton Bay Marine Park (a,b) open to fishing, (c,d) closed to fishing since 1 March 2009 and (e,f) closed to fishing since 1 December 1997. Upper bin values for each 5-mm size category end with 4 or 9. Parameter values and correlation coefficients for Gaussian curves given in Appendix 3..... 70

- Figure 8.12.** Cumulative size frequency of *Scylla serrata* caught in polyethylene-mesh pots in areas of the Moreton Bay Marine Park open to fishing (Open), closed to fishing since 1 March 2009 (New green) and closed to fishing since 1 December 1997 (Old green). Plots a) and b) show data for males and females, respectively. Plot c) shows data for both sexes combined. Upper bin values for each 5-mm size category end with 4 or 9. The dotted vertical line shows the minimum legal size for males harvested by the Qld mud crab fishery.....71
- Figure 10.1** Article by Tony Riesenweber promoting the use of escape vents in Qld.....84
- Figure 10.2.** Media release from Qld Department of Agriculture, Fisheries and Forestry regarding testing of escape vents by commercial crabbers in that state.....85
- Figure 17.1.** Parameter estimates and correlation coefficients (Adjusted r^2) for Gaussian curves fitted to relative size frequency data. The basic form of the equations is $y = a_n^{-(x-b_n)/c_n)^2}$, with the right hand side of the equation repeated once or twice in those cases where there are two or three modes, respectively.92
- Figure 22.1.** Schematics for 120 mm x 46 mm (W x H) escape vents (sized to retain *Scylla serrata* ≥ 140 mm carapace width) produced by Lincoln Plastics. Device thickness is 5 mm. The holes in the middle of the short edges have since been removed as they caused weak points. Likewise, the recess on the left side of the device has also been removed.....98
- Figure 22.2.** Schematics for 120 mm x 50 mm (W x H) escape vents (sized to retain *Scylla serrata* ≥ 150 mm carapace width) produced by Lincoln Plastics. Device thickness is 5 mm. The holes in the middle of the short edges have since been removed as they caused weak points. Likewise, the recess on the left side of the device has also been removed.....98

ACKNOWLEDGEMENTS

Our sincere thanks go to Sherwood Thorbjornsen for coordinating the construction of wire-mesh pots, transport of pots and fuel to Tomato Island and Port Roper and the distribution of escape vents to mud crab fishers in the Northern Territory (NT). Advice and assistance received from commercial mud crab licensees and leasees Neil Bradley, Doug Neville, Vu Van Nguyen and Tam Van Nguyen are also greatly appreciated.

Shane Davidson of Territory Laser Cutting is thanked for his patience during escape vent prototyping. Likewise, John Harpas and Malcolm Fisher of Lincoln Plastics are recognised for their assistance with regard to plastic injection moulding of escape vents. We are grateful to Ron Larsen of Crabmaster Systems for providing polyethylene (PE)-mesh pots at wholesale price and for his advice on the project.

Laurence Ah Toy and Paul Reid are thanked for allowing us to use their camp sites/facilities during field work on the Adelaide and Roper rivers, respectively. We are also grateful to past and present staff of the NT Department of Primary Industry and Fisheries (DPIF) (and volunteers) that provided technical support during this study. The contributions of those who assisted with former mud crab research and monitoring programs in the NT and Queensland (Qld), analysed herein, is also acknowledged.

James Webley and James McGilvray, Qld Department of Agriculture, Fisheries and Forestry (Qld DAFF) are thanked for assisting with the provision and interpretation of mud crab data from the Qld Long Term Monitoring Program. Likewise, we are grateful to Richard Pillans Commonwealth Scientific and Industrial Research Organisation (CSIRO) for providing mud crab data from the Moreton Bay Marine Park Monitoring Program. Gavin Leese (Qld DAFF) is also acknowledged for distributing escape vents to commercial fishers in Qld.

This report benefitted from comments made by two independent referees. Andria Handley and Thor Saunders are thanked for proofing the final draft.

FRDC 2010/042 Improving Gear Selectivity in Australian Mud Crab Fisheries

PRINCIPAL INVESTIGATOR

Mark Grubert

ADDRESS

Fisheries Division
Department of Primary Industry and Fisheries
GPO Box 3000 Darwin, NT 0801
Telephone: 08 8999 2167 Fax: 08 8999 2065

OBJECTIVES

1. Describe the ratio and size distribution of "legal-sized" and "under-sized" mud crabs retained by different pot types used in Australian mud crab fisheries.
2. Quantify any change in the retention of under-sized mud crabs (and other bycatch) by pots fitted with different mesh sizes or escape vents.
3. Provide advice to managers on optimal mesh sizes, escape vent dimensions and the number of escape vents necessary to minimise the retention of under-sized mud crabs relevant to the local size limits and species.

1 NON TECHNICAL SUMMARY

OUTCOMES ACHIEVED TO DATE

A major outcome of this project was the adoption of escape vents by a large number of commercial mud crab fishers in both the Northern Territory (NT) and Queensland (Qld). This has been achieved through collaboration between local (NT) mud crab fishers and wholesalers, as well as members of the Qld DAFF fisheries observer team.

The design of the devices has benefitted from input from crab fishers in both jurisdictions. Unit production costs during the initial prototyping phase (using laser cutting) were relatively high (~\$5 each) but these costs have been significantly reduced (to ~50c each) by transitioning to plastic injection moulding.

Based on the results of this study, the use of two escape vents is expected to decrease the catch of under-sized mud crabs by up to 40% (depending on the size structure of the population). This in turn should result in significant decreases in the rates of within-pot cannibalism, handling time/mortality and post-release mortality of under-sized crabs. Catch rates of legal-sized crabs may also increase by up to 30%.

Any increase in the harvest of legal-sized crabs will (at least to some degree), be offset by the greater survivorship of under-sized crabs. However, if subsequent harvest rates are considered excessive, then the dimensions of the escape vents can be increased to the point where all under-sized crabs (and a proportion of legal-sized crabs) exit the pot and the harvest rate returns to its former level.

This project tested the effectiveness of three sizes of escape vent suited to different minimum legal sizes (MLSs) for male mud crabs (*Scylla* sp.) harvested in Australia. The size of the vents was based on male body shape because the MLSs for this sex are either the same or 10 mm lower than those for female mud crabs (depending on jurisdiction).

There was considerable variation in the length and height of crabs for a given width and so the escape vents were sized to retain all legal-sized crabs rather than allow the escape of all under-sized crabs.

The devices were fitted to two styles of crab pot, constructed of either polyethylene (PE) mesh or galvanised wire mesh. One of the three sizes of escape vents (110 mm W x 46 mm H) were fitted to wire-mesh pots, and the other two sizes (120 mm W x 42 mm H and 120 mm W x 50 mm H) fitted (separately) to PE-mesh pots. The number of vents fitted to the wire-mesh pots ranged from zero (control) to four, whereas the number fitted to PE-mesh pots was either zero (control) or two.

Wire-mesh pots were tested in the Roper River only, while PE-mesh pots were tested in both the Roper and Adelaide rivers with 90% of the pot-lifts taking place in the latter system. Mean crab size, as carapace width (CW) was significantly greater in the Adelaide River than in the Roper River, which in turn highlighted regional differences in the effectiveness of escape vents.

The decrease in the retention of under-sized crabs (relative to control pots) in vented PE-mesh pots set in the Adelaide River was 20% and 40% for the 42 mm and 50 mm escape vents, respectively. Corresponding figures for the Roper River were a 2% increase and 4% decrease in under-sized crabs, respectively.

Based on this observation, we suggest that the probability of an under-sized crab using an escape vent will increase proportionally to the difference between its CW and that of other (larger) crabs that enter the pot.

Put simply, a small crab will be less stressed in a pot with other small crabs and more stressed (and more likely to use the escape vent) if a much larger crab enters.

In some instances, the use of escape vents increased the catch rate of legal-sized crabs by up to 30%. This phenomenon has been observed before but is by no means universal. A common explanation in such cases is that small crabs that escape through vents free up space inside the pot for other, potentially larger, crabs to enter and be retained.

However, our data does not concur with this line of argument. The greatest increase in the proportion of legal-sized crabs caught in vented PE-mesh pots was in the Roper River, where the reduction in under-sized crabs was minimal or non-existent. We do not have an explanation for this observation but are mindful of the large difference in sampling effort (using PE-mesh pots) between the Roper and Adelaide rivers during this study.

The trial using wire-mesh pots, conducted on the Roper River only, indicated that fitting more than two escape vents may be counter-productive as the catch rate of legal-sized crabs in pots with three or four escape vents was less than that in control pots. Given the above mentioned regional differences in catches of legal-sized crabs in vented PE-mesh pots, we cannot make a definitive recommendation in terms of the optimal number of escape vents at this stage.

Vented pots retained fewer bycatch (primarily fish and other crustaceans) than unvented pots. The incidence of bycatch in PE-mesh pots was greater in the Adelaide River than in the Roper River. The fish bycatch rate (per 100 pot-lifts) of PE-mesh pots set in the Roper River was around four times greater than of wire-mesh pots set in the same system.

Residual funds from this project were used to engage a plastic manufacturer (Lincoln Plastics, South Australia) to produce two sizes of escape vents via plastic injection moulding. The vents are specifically designed to fit wire-mesh pots (although they can be fitted to PE-mesh pots) and sized to retain crabs ≥ 140 mm CW or ≥ 150 mm CW.

Industry testing of the first batch of injection-moulded escape vents revealed that holes on the vertical sides of the devices formed a weak spot that caused breakages. The mould was then modified and the problem eliminated. Crabbers can now purchase escape vents direct from the manufacturer for around 50c each, noting there is a minimum quantity for a production run.

KEYWORDS: Giant Mud Crab, *Scylla serrata*, gear selectivity, escape vents, bycatch

2 BACKGROUND

Mud crabs of the genus *Scylla* (de Haan, 1833) occupy mangrove and mud flat habitats across most of the Indo-West Pacific (Macnae, 1968) and support important commercial, recreational and Indigenous fisheries in this region (Brown, 1993; Henry and Lyle, 2003). The largest and most widespread member of this group, the Giant Mud Crab (*S. serrata*) (Forskål, 1775; Figure 2.1), forms the basis of sizable pot capture fisheries in New South Wales (NSW), the NT and Qld.

The commercial harvest of this species varies from year to year but is typically greatest in Qld (~1200 tonnes in 2010, Fisheries Qld 2011) followed by the NT (~400 tonnes in 2010, NT Government 2011) and NSW (~100 tonnes in the 2010-11 fiscal year, Kevin Rowling, NSW Department of Primary Industries, (pers. comm.)). The recreational take of *S. serrata* in Australia is also significant, at around 800 tonnes. Most crabs (92%) are caught in traps, with pots (as passive fishing enclosures) accounting for the majority (85%) of the fishing effort within the trap category, which also includes actively-fished devices such as “dillies” (Henry and Lyle, 2003).



Figure 2.1. Commercially harvested Giant Mud Crabs (*Scylla serrata*) tied and ready for market

Each relevant state and territory imposes an MLS to limit the harvest of immature *S. serrata*, but the body measurements used and magnitude of the MLSs differ between jurisdictions (Table 2.1). The way in which pots are constructed also varies, with some made of PE mesh (ranging from 25 x 25 mm to 50 x 50 mm) stretched over a circular or rectangular perimeter framework, which is often collapsible (Figure 2.2) and others shaped from 10 gauge (2.6-mm diameter) galvanised wire mesh 50 mm x 75 mm (Figure 2.3). Restrictions on pot dimensions also differ between jurisdictions; most impose a maximum distance of no more than 1.0 to 1.5 m in any direction and 0.5 m³ in volume.

Table 2.1. Minimum legal sizes (MLSs; mm) applied to *Scylla serrata* within its Australian range. Expressed as carapace width (CW) except in NSW where carapace length (CL) is used. *85 mm CL approximates 125 mm CW for NSW crabs (Paul Butcher, pers. comm.). **Recreational fishers in WA are not permitted to use pots and the commercial mud crab fishery (which can use pots) is comparatively small (~5 tonnes per annum; Danielle Johnstone, WA Fisheries, pers. comm.).

Jurisdiction	Sector	MLS (mm)	
		Male	Female
Qld	All	150	No take
NT	Recreational	130	140
	Commercial	140	150
NSW*	All	85	85
WA**	All	150	150



Figure 2.2. Two styles of collapsible polyethylene-mesh pots. The rectangular pot folds and locks in the centre of the longest axis (similar to a purse). The circular pot is held open by four grooved PVC uprights that, when disengaged from the top hoop, allow the pot to fold flat.

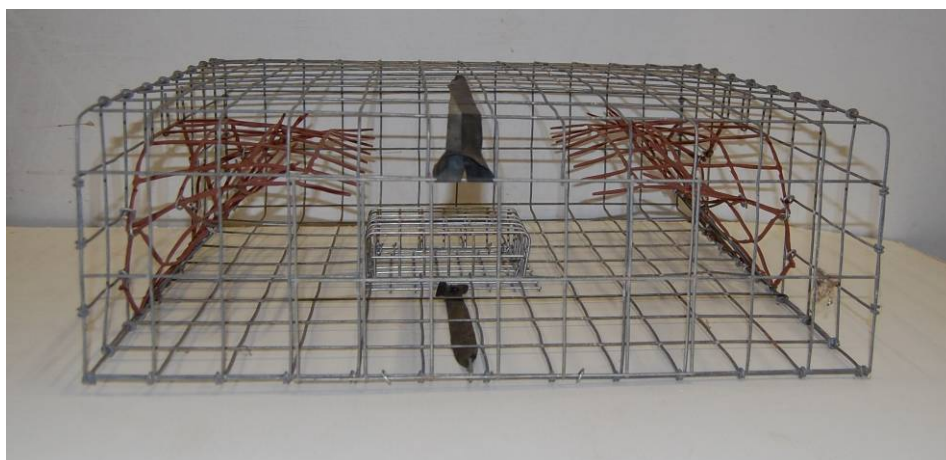

Figure 2.3. A wire-mesh pot with two funnels and central bait box. The upper and lower rubber straps hold closed the doors to the main chamber and bait box, respectively.

The proportion of under-sized *S. serrata* caught by these fisheries is moderate to high, irrespective of the mesh sizes used. For example, discard rate for the NT commercial fishery (where all pots are manufactured from the largest mesh listed above) ranges from 36% to 72% depending on location (derived from Ward et al. 2008), whilst that for the NT recreational fishery (where finer PE-mesh pots are preferred) is approximately 39% (Coleman, 2004), noting the smaller size limit for this sector. Estimates from NSW and Qld are similar at 37% and 34%, respectively (Butcher, 2004; Qld Government, 2011), although the latter figure only refers to under-sized males, as all females are protected in Qld and must be released.

The retention and handling of large numbers of under-sized *S. serrata* by these fisheries is thought to have a negative impact on both the crab population and fishing efficiency. Both the causes of, and possible solutions to, these problems are described in greater detail in the next section.

3 NEED

Pots are an effective and popular means of capturing the Giant Mud Crabs (*S. serrata*) in Australia. However, the use of this gear results in the retention and handling of large numbers of under-sized crabs, 30 to 70% of the total catch depending on location (Butcher, 2004; Coleman, 2004; Ward et al., 2008). This situation is problematic for a number of reasons: crabs may be cannibalised by others within the pot, are subject to stress or damage during the grading process, or fall victim to predators when released.

Entrapment and handling of undersize crabs also cause compliance issues (see Fisheries Qld, 2011) and reduce the efficiency of commercial crabbing operations. Several species of fishes also get caught in mud crab pots (Hay et al., 2005; Fisheries Qld, 2011; Butcher, et al., 2012) with similar consequences.

Two potential means to mitigate these problems are to change to a larger mesh size or to fit escape vents that enable captive under-sized crabs (and small teleost bycatch) to exit the pots and avoid possible stress, injury or death. Such changes may also lessen the incidence of ghost fishing by lost or abandoned gear.

Given the above, there is a clear need to investigate practical measures to improve gear selectivity in Australian mud crab fisheries so as to reduce their environmental footprint and increase their efficiency.

4 OBJECTIVES

The objectives of this project were as follows:

1. Describe the ratio and size distribution of "legal-sized" and "under-sized" mud crabs retained by different pot types used in Australian mud crab fisheries.
2. Quantify any change in the retention of under-sized mud crabs (and other bycatch) by pots fitted with different mesh sizes or escape vents.
3. Provide advice to managers as to optimal mesh sizes, escape vent dimensions and the number of escape vents necessary to minimise the retention of under-sized mud crabs relevant to the local size limits and species.

Initial investigations into the use of larger mesh sizes indicated that this was not a viable option because of difficulties in sourcing appropriate materials. Another consideration was that, in the case of flexible PE twine, the use of larger panel sizes may lead to the entanglement of more and/or larger bycatch. Hence, the remainder of this work concentrates on the use of escape vents as a means of improving the selectivity of mud crab pots.

5 A DESCRIPTION OF SELECTED MORPHOMETRIC RELATIONSHIPS FOR THE GIANT MUD CRAB (*Scylla serrata*) AND IMPLICATIONS FOR THE SIZING OF ESCAPE VENTS SUITED TO THIS SPECIES

5.1 INTRODUCTION

Escape vents can improve the selectivity of crab pots by providing an opening through which under-sized animals can pass but legal-sized animals cannot (Miller, 1990). Correct sizing of the opening is critical, as too small a gap will mean that few under-sized crabs escape, whilst too large a gap can result in the loss of legal-sized crabs. The shape of the opening (be it circular, elliptical, rectangular or square) can also affect its performance (Krouse, 1978; Eldridge et al., 1979; Boutson et al., 2009), although there is little conclusive evidence of an optimal vent shape for crab pots. The number and positioning of escape vents is also important (Eldridge et al., 1979; Jirapunpipat et al., 2008; Havens et al., 2009), with most works suggesting at least two vents be fitted along the bottom edge of the pot.

Crabs move sideways and so it is their total length (TL) from the tip of the longest frontal median spine [if different] to the posterior edge of the abdominal flap and carapace height (CH), the maximum dorso-ventral distance, which determine their ability to pass through an escape vent of a given size. Neither of these distances is used as MLS for mud crabs (*Scylla* spp.) in Australia. CW, measured between the tips of the ninth antero-lateral spines is used in the NT, Qld and Western Australia (WA), whilst carapace length (CL), the distance between the posterior margin of the carapace and the base of the notch between the frontal median spines, is used in NSW.

This chapter examines the relationships between these measurements as a first step in the process of sizing escape vents suited to the various MLSs applied to Giant Mud Crab (*Scylla serrata*) fisheries in Australia (Table 2.1). Only rectangular vents (with a width at least twice the height) are considered here as Giant Mud Crabs are dorso-ventrally flattened and can easily pass (or be passed) through a gap of this shape (pers. obs.). This type of rectangle also has a smaller surface area than a circle or square of the same width, a feature which may limit the ingress of under-sized crabs (and small bycatch) compared with the other shapes. A further benefit of rectangular escape vents is their ease of fitment to pots formed from rectangular (75 mm x 50 mm) galvanised wire mesh, which is the preferred material when durability is paramount.

5.2 MATERIALS AND METHODS

CH, CL and TL measurements (± 1 mm) were recorded for five male and five female *S. serrata* in each 1 mm CW category across a size range of 120 to 160 mm CW for males and 130 to 170 mm CW for females ($n = 205$ for each sex). The crabs were caught in the Adelaide and Roper rivers (Figure 5.1) between May 2009 and June 2009 and records were taken during commercial fishing operations or at processing facilities in Darwin. Ovigerous females were not considered here as they very rarely enter pots (Knuckey, 1999).

Least squares linear regressions were performed on the CW x CH, CW x TL, CL x CH and CL x TL datasets to determine the slopes, intercepts and regression coefficients for each morphometric relationship. Absolute values of the difference between the predicted y (from the regression equation) and the upper and lower measurements of y for each value of x were then calculated for each relationship. The maximum values derived through this process were then added and subtracted from the y -intercept of the corresponding regression equation to produce two lines, one forming an upper boundary to the data and the other forming a lower boundary.

The boundary lines were then overlaid on each dataset and their equations were used to calculate upper and lower estimates of CH and TL for the different MLSs applied to male *S. serrata* in Australia (the MLSs for males being the same or lower than those for females). These dimensions then serve as a guide to the sizing of prototype escape vents.

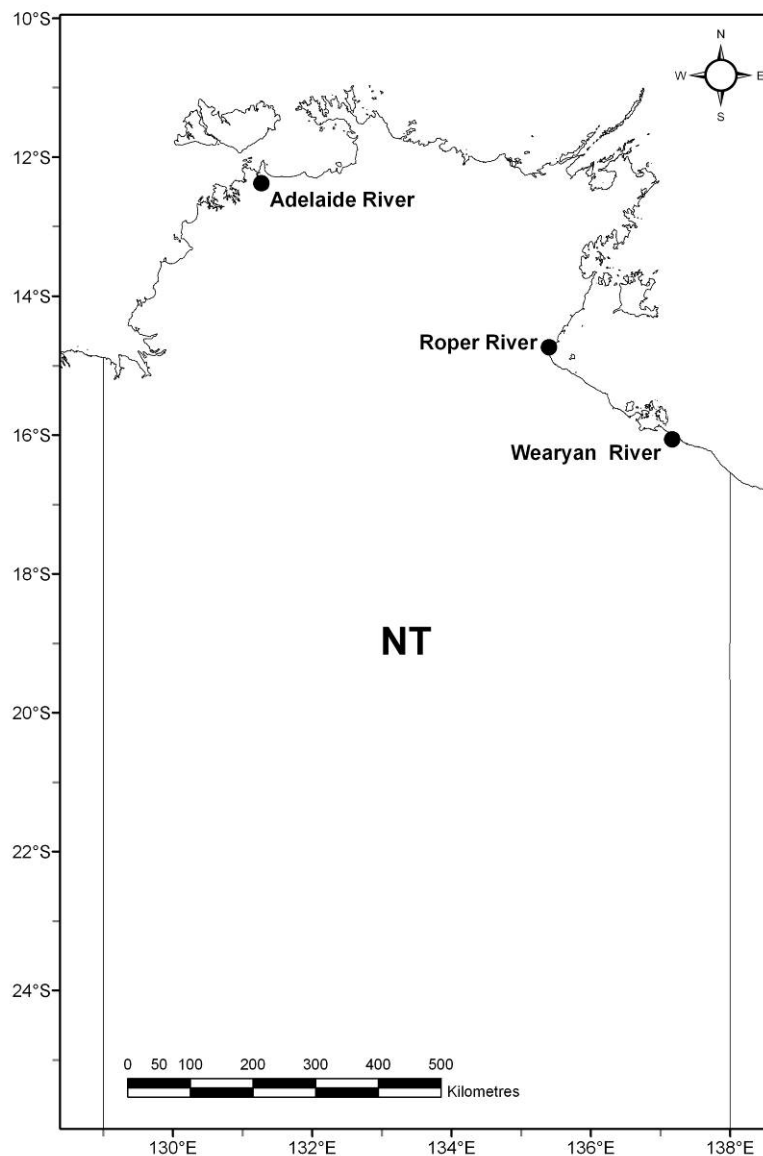

Figure 5.1. Location of sampling/fisher feedback sites in the Northern Territory (NT)

Discussions with several commercial mud crab fishers in the NT indicated that they were keen to trial escape vents provided they retain all legal-sized mud crabs rather than allow the escape of all under-sized animals. With this in mind, the inner dimensions (W x H) of the devices were derived from the equations for the upper boundary line for the CW x TL relationship and the lower boundary line for the CW x CH relationship using an x-value of 140 mm (the smaller of the two MLSs for this fishery). This combination allows the “longest” of the under-sized crabs to escape but limits the passage of all but the “shallowest” of the legal-sized crabs. The outer dimensions of the escape vent plates were 90 mm x 150 mm (H x W), which approximates that of three wire mesh panels running lengthways (as shown in Figure 2.3).

The prototype vents were laser cut from 1.2-mm thick stainless steel sheet and distributed to commercial mud crab fishers operating on the Adelaide, Roper and Wearyan rivers (Figure 5.1) to establish if they could pass any of their catch at or above 140 mm CW through the gap (see the Results Section for dimensions and feedback). This method of assessment is based on the generalisation by Stasko (1975) who stated that both crabs (*Cancer irroratus*) and lobsters (*Homarus americanus*) orientate themselves such that the smallest opening they can be pushed through by hand is also the smallest opening they can pass through unaided.

5.3 RESULTS

Both CH and TL showed strong positive, linear relationships with CW (Figure 5.2). The maximum difference between the predicted y and the upper and lower measurements of y (for a given x) were 4 mm and 6 mm for the CW x CH and CW x TL datasets, respectively. Upper and lower estimates of CH and TL for CW values of 130, 140 and 150 mm (the MLSs in the NT and Qld) are given in Table 5.1. Inner dimensions of the prototype escape vents are highlighted in bold.

CH and TL also showed strong positive, linear relationships with CL (Figure 5.3). The maximum difference between the predicted y and the upper and lower measurements of y was 4 mm for both the CL x CH and CL x TL datasets. Upper and lower estimates of CH and TL for a CL value of 87 mm (MLS in NSW) are given in Table 5.2.

Feedback regarding the suitability of prototype escape vents was generally positive, although one fisher from the Wearyan River (15°57'45"S, 136°50'21"E) did report that he was able to pass some male crabs at and above 140 mm CW through the prototype units. This was confirmed when we checked a sample of his catch ($n = 100$; all males ≥ 140 mm and all females ≥ 150 mm) in Darwin. Three of the four male crabs measuring 140 mm CW had a CH less than 48 mm as did one male crab measuring 143 mm CW.

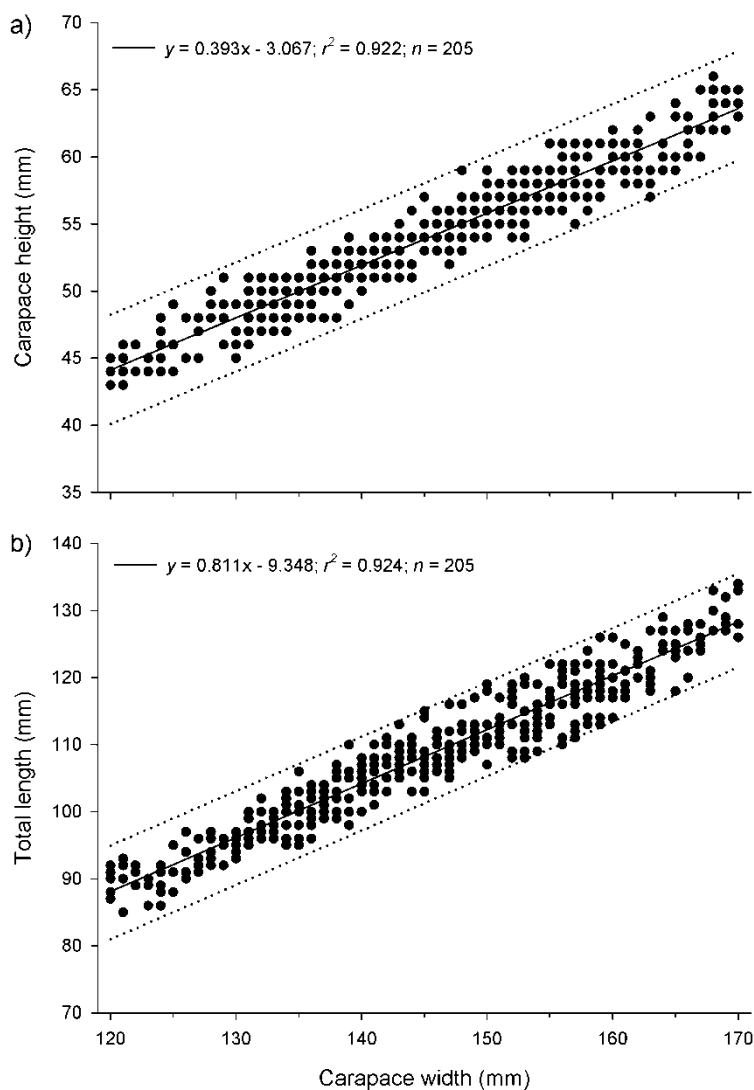

Figure 5.2. Plots of a) carapace height and b) total length versus carapace width for the Giant Mud Crab (*Scylla serrata*). The dashed lines which bound the data in each plot have the same slopes, but different intercepts (± 4 mm in a; ± 6 mm in b) as the corresponding regression equations.

Table 5.1. Upper and lower estimates of carapace height (escape vent height) and total length (escape vent width) for minimum legal sizes of 130 mm, 140 mm and 150 mm carapace width (CW) (based on the equations for the dashed boundary lines in Figure 5.2) for *Scylla serrata*. The dimensions in bold were adopted for the prototype escape vents suited to retain crabs ≥ 140 mm CW.

Carapace width (mm; x)	Carapace height (mm; y)		Total length (mm; y)	
	Lower ^a	Upper ^b	Lower ^c	Upper ^d
130	44	48	90	102
140	48	56	98	110
150	52	60	106	118

^a using $y = 0.393x - 7.067$; ^b using $y = 0.393x + 1.067$; equations for dashed lines in Figure 5.2a

^c using $y = 0.811x - 3.348$; ^d using $y = 0.811x - 15.348$; equations for dashed lines in Figure 5.2b

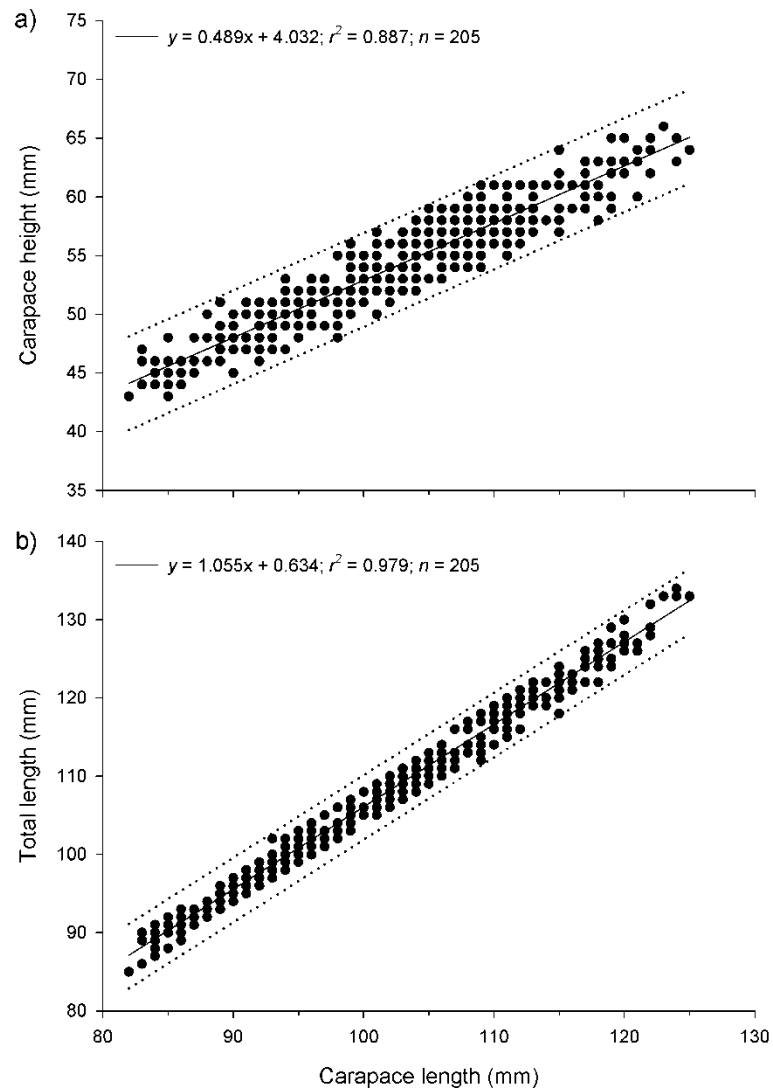

Figure 5.3. Plots of a) carapace height and b) total length versus carapace length for the Giant Mud Crab (*Scylla serrata*). The dashed lines which bound the data in each plot have the same slopes, but different intercepts (± 4 mm) as the corresponding regression equations.

Table 5.2. Upper and lower estimates of carapace height (escape vent height) and total length (escape vent width) for a minimum legal size of 85 mm carapace length (based on the equations for the dashed boundary lines in Figure 5.3) for *Scylla serrata*

Carapace length (mm; x)	Carapace height (mm; y)		Total length (mm; y)	
	Lower ^a	Upper ^b	Lower ^c	Upper ^d
85	42	50	86	94

^a using $y = 0.489x + 0.032$; ^b using $y = 0.489x + 8.032$; equations for dashed lines in Figure 5.3a

^c using $y = 1.055x - 3.366$; ^d using $y = 1.055x + 4.634$; equations for dashed lines in Figure 5.3b

5.4 DISCUSSION

This work found positive, linear relationships between each of the four morphometric relationships examined. These relationships were then used to derive upper and lower estimates of escape vent height and width for each of the different MLSs used in Australian mud crab fisheries.

Prototype escape vents measuring 48 mm high and 110 mm wide and designed to retain all crabs ≥ 140 mm CW (based on equations shown in Table 5.1) failed to do so, as roughly 5% of the legal-sized males from the Wearyan River (which was not sampled during the morphometric analysis) were less than 48 mm deep and could be passed through the device. Consequently, we reduced the intercept (whilst retaining the slope) of the lower boundary line for the CH x CW relationship by 2 mm. The revised escape vent dimensions and boundary line equations are given in Table 5.3.

Table 5.3. Revised upper and lower estimates of carapace height (escape vent height) and total length (escape vent width) for minimum legal sizes of 130 mm, 140 mm and 150 mm carapace width for *Scylla serrata*

Carapace width (mm; x)	Carapace height (mm; y)		Total length (mm; y)	
	Lower ^a	Upper ^b	Lower ^c	Upper ^d
130	42	48	90	102
140	46	56	98	110
150	50	60	106	118

^a using $y = 0.393x - 9.067$; ^b using $y = 0.393x + 1.067$

^c using $y = 0.811x - 3.348$; ^d using $y = 0.811x - 15.348$

The fact that the CH of some legal-sized males from the Wearyan River was less than that for legal-sized males sampled from the Adelaide and Roper rivers suggests that the CW x CH relationship for *S. serrata* may vary by region or river system. Support for this idea comes from the work of Rudershausen and Turano (2009) who reported significant differences in the CW x CL relationships for blue crabs (*Callinectes sapidus*) caught in seven different estuaries in North Carolina.

The potential for regional variation in morphometric relationships highlights the need to sample from as many areas as possible when determining escape vent sizes and/or testing the effectiveness of these devices.

6 THE EFFECT OF DIFFERENT NUMBERS OF ESCAPE VENTS ON CATCH RATES OF UNDER-SIZED AND LEGAL-SIZED GIANT MUD CRABS (*Scylla serrata*) IN WIRE-MESH POTS

6.1 INTRODUCTION

The Giant Mud Crab (*Scylla serrata*, Forskål, 1775) is the largest and most widespread of the four species of *Scylla* found in mangrove and mud flat habitats of the Indo-West Pacific (Keenan et al., 1998). A combination of simple, low-cost capture methods and excellent eating qualities means that this species is targeted by commercial, recreational and subsistence fishers throughout most of its geographic range (Brown, 1993). The commercial harvest of *S. serrata* in the NT is undertaken exclusively using baited, galvanised wire-mesh traps (pots) and is managed through a range of catch and gear controls that have changed to various degrees over time. The Orange Mud Crab (*S. olivacea*) is occasionally caught along the western coast of the NT but constitutes <1% of the commercial harvest (Hay and Calogeras, 2000). Hence, the fishery is considered mono-specific for management purposes.

An MLS of 130 mm CW was applied to both sexes in 1985, with the MLS for females being increased to 140 mm CW in 1996 (Hay and Calogeras, 2000). A significant (~65%) decline in both the commercial catch and catch rate between 2001 and 2003 led to a further increase in the MLS (to 140 mm CW for males and 150 mm CW for females) in 2006. However, this change only applied to the commercial sector, while the MLS for recreationally-harvested crabs remaining unchanged.

All commercial pots used in the NT are constructed by hand from 10 gauge (2.6 mm diameter) galvanised wire mesh (75 mm wide x 50 mm high) and have been for at least 20 years. This material was considered highly selective towards legal-sized crabs when the fishery began (Mounsey, 1989; Knuckey, 1999) but has become less so as the MLS has been progressively increased. Hence, the proportion of under-sized crabs (particularly females) handled and discarded now is greater than that under previous arrangements. This in turn may have increased the rate of handling damage and post-release mortality, thereby negating some of the benefits of the larger MLSs.

Building pots from mesh with larger apertures (to improve selectivity) is one option, but we have so far been unable to source such a product. Another possible means of reducing the retention of under-sized *S. serrata* in this gear is to fit escape vents, given their effectiveness in other crab and lobster fisheries around the world (e.g. Krouse, 1978; Brown, 1982; Miller, 1990; Stevens, 1995; Guillory and Hein, 1998). Indeed, the use of these devices as it relates to the NT mud crab fishery was raised at least 14 years ago by Knuckey (1999).

The primary aim of this study was to compare catch rates of under-sized and legal-sized *S. serrata* in conventional rectangular, galvanised wire-mesh pots (hereafter called “wire-mesh pots”) with that of pots fitted with different numbers (one to four) of identically-sized escape vents. A secondary aim was to quantify bycatch retention in the control and treatment groups.

6.2 MATERIALS AND METHODS

6.2.1 Description of gear

Seventy wire-mesh pots (2.6 mm wire thickness, 75 mm x 50 mm [W x H] mesh size) were purchased from a local mud crab fishery licensee (Bevwood Pty Ltd, Humpty Doo, NT). The pots measured 600 mm x 700 mm x 200 mm (W x L x H) and had two funnel mouths (300 mm x 150 mm [W x H]) cut centrally from the bottom of the longest axis and a 450 g zinc anode wired into the mesh to reduce electrolysis of the pot. Total pot volume was approximately 0.08 m³.

A single strip of 40 mm x 40 mm plastic mesh projected (in a V-shape) roughly 200 mm inside the pot from the funnel mouth. A hinged “crab door” measuring 300 mm x 150 mm (W x H), and made of the same mesh as the body of the pot, was fitted to one side (perpendicular to the funnels) and was held shut by a hooked rubber strap.

A bait box was formed by removing four mesh panels (2 x 2) from the underside of the pot and installing an inverted wire mesh tray (2.0 mm wire thickness, 20 mm x 20 mm mesh size) measuring 100 mm x 150 mm x 45 mm (W x L x H). The tray was then covered by an oversized hinged door (made of the same mesh as the tray) on the outside of the pot, again held shut by a hooked rubber strap.

Each of the six treatment groups (note spaces deliberately omitted from their names) consisted of eight pots fitted with either one escape vent (1x46mm), two escape vents on the same side of the pot (2x46mm{same}), two escape vents on directly opposite sides of the pot (2x46mm{opp}), two diagonally opposing escape vents (2x46mm{diag}), three (3x46mm) or four (4x46mm) escape vents (Figure 6.1). Escape vent height was set at 46 mm and width at 110 mm which correspond to the estimated minimum and maximum CH and TL values for crabs at 140 mm CW, respectively (Table 5.3). The intent here being to retain all crabs ≥ 140 mm CW rather than allow the escape of all under-sized crabs.

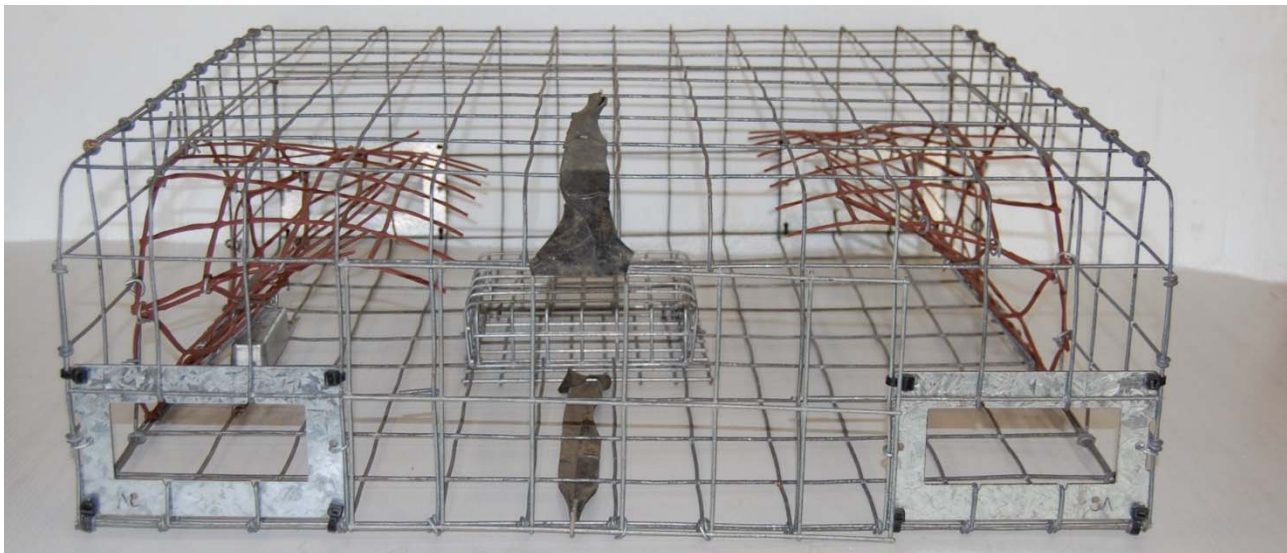

Figure 6.1. A wire-mesh pot with four escape vents fitted

An 8-mm diameter, 8-m long polypropylene rope, with a colour coded and numbered ellipsoid float (220 mm long x 120 mm maximum diameter) at the distal end was tied to the top of the pot. Unvented control pots (excluding the rope and float) weighed 3.25 kg in air. Treatment pots weighed multiples of 120 g more than the control pots depending on the number of escape vents fitted.

6.2.2 Study site and sampling regime

The Roper River is a large, perennial, eastward flowing river originating near Mataranka (14°55'31"S, 133°04'08"E, NT) that discharges into the Limmen Bight, on the western side of the Gulf of Carpentaria (GOC) (Figure 6.2). The maximum tidal range at the mouth of the river is approximately 3 m, with the tidal influence extending 145 km upstream to a concrete causeway at “Roper Bar”, 14°42'49"S, 134°30'24"E (Faulks, 2001).

The flow rate of the Roper River is heavily influenced by the wet/dry monsoonal weather pattern with mean monthly discharge rates ranging from $1 \text{ m}^3\text{s}^{-1}$ in September-October (at the end of the dry season) to $500 \text{ m}^3\text{s}^{-1}$ in March (at the end of the wet season) (Faulks, 2001). The transitional periods, before and after the wet season are known locally as the “build-up” and “run-off”, respectively.

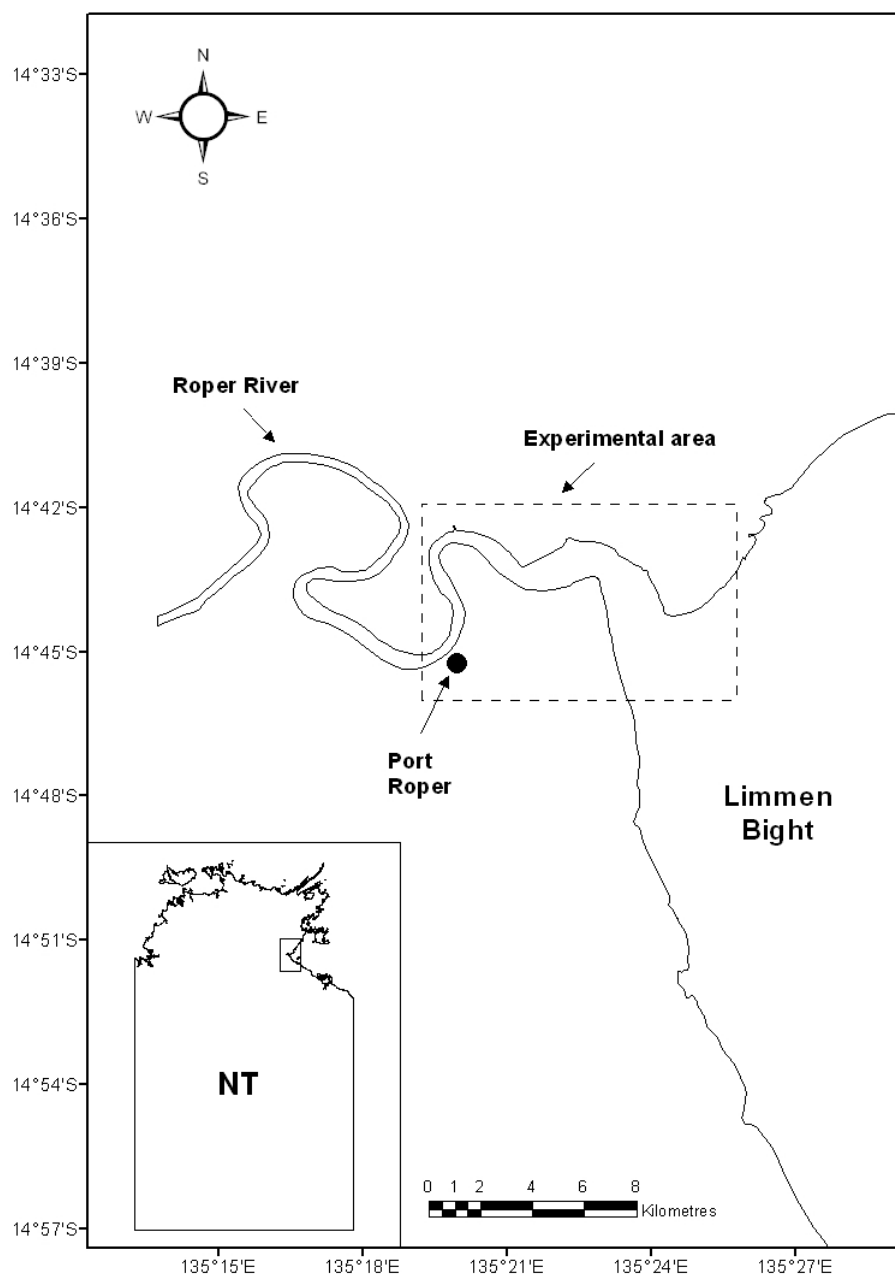

Figure 6.2. Location of the Roper River, Northern Territory (NT)

The lower reaches of the Roper River consist of a defined channel with large areas of mud and/or sand flats either side that merge into narrow stands of mangrove forest. Commercial crabbing in the Roper River and surrounds began in the early 1990s and has been continuous since (with the exception of the period from November to March, when flooding prohibits road access).

Experimental crab fishing on the Roper River took place in July-August 2010, October 2010 and May 2011, hereafter called the dry, build-up and run-off sampling periods, respectively (see Table 6.1 for exact dates).

The run-off experiment was planned to take place in March-April 2011 but was postponed several times due to flooding and consequent difficulties accessing the area by road.

The work was conducted at or inside the mouth of the Roper River (rather than on coastal mud flats along Limmen Bight where commercial crabbers operate) so as to reduce transit times, limit exposure to wind (and wind-driven swell) and enable us to safely and reliably check the pots twice per day. Whilst most commercial crabbing in the GOC occurs on coastal mud flats, crabbers in this and other areas do operate inside creeks and estuaries, a prime example being the Adelaide River near Darwin.

Table 6.1. Sampling dates, minimum and maximum predicted daily tidal amplitude (TA) for each trip to the Roper River

Season	Start date	End date	Minimum TA (m)	Maximum TA (m)
Dry	27 July 2010	3 August 2010	0.2	1.8
Build-up	7 October 2010	12 October 2010	0.5	2.1
Run-off	24 May 2011	29 May 2011	0.3	1.5

6.2.3 Experimental procedures

Randomised block design

This study employed a randomised block design in order to mitigate potential temporal and/or spatial effects on catchability and/or size structure of Giant Mud Crabs. Fishing gear was grouped into eight blocks of seven pots (one control and one each of the six different treatment pots) giving a total of 56 pots. Five blocks were set from one vessel and three from another, in different areas of the river.

Pot deployment

Pots were set roughly 100 m apart in depths ranging from 0.5 to 4.0 m within 2 hours of the top of the tide. The pot order within each block was changed each set according to a random number list generated in Microsoft Excel 2007 (Redmond, WA, USA). All pots were baited with ~300 g portions of horse meat and the date, time, latitude and longitude of each were set recorded. Consistently low catch rates in an area for anything more than 24 hours prompted the movement of pots to other locations within the experimental area.

Pot retrieval and data recording

Pots were hauled between 4 and 24 hours post set, which is typical of the NT commercial fishery where pots are checked at least once daily and twice if conditions allow. Haul date and time, pot damage and the presence/absence of bait were recorded prior to sorting/measuring the catch. Some pots dried between successive hauls and so the interval between hauls cannot be considered as "soak time".

Mud crabs were identified to species, sexed and had their CW measured (± 1 mm). Any damage to the carapace or infection with the Rhizocephalan parasite *Loxothylacus ihlei* (Knuckey et al., 1995) was also recorded. Limb loss was quantified using a sign (-ve = left; +ve = right; viewed from the dorsal side) and a numbering system that referred to the chelae (claws) as 1; the first, second and third pereopods (walking legs) as 2, 3 and 4, respectively, and the pleopods (swimmerets) as 5. For example, a crab missing its claw on the right hand side and its swimmeret on the left hand side was scored +1, -5.

Each mud crab was assigned a qualitative moult index (MI) value based on the degree of flex in the exoskeleton at the points shown in Figure 6.3 as well as the criteria listed below (modified from Hay et al., 2005):

MI1 (post moult – commercially unsuitable crabs): clean shell, no wear on chelae, relatively light for size, highly flexible at test points

MI2 (early inter-moult – borderline stage but still commercially unsuitable): few (if any) epibionts on shell, some wear on chelae, intermediate weight for size, moderately flexible at test points

MI3 (mid/late inter-moult – commercially acceptable crabs): epibionts (if present) may be numerous and/or large, significant wear on chelae, heavy for size, no flex at test points.

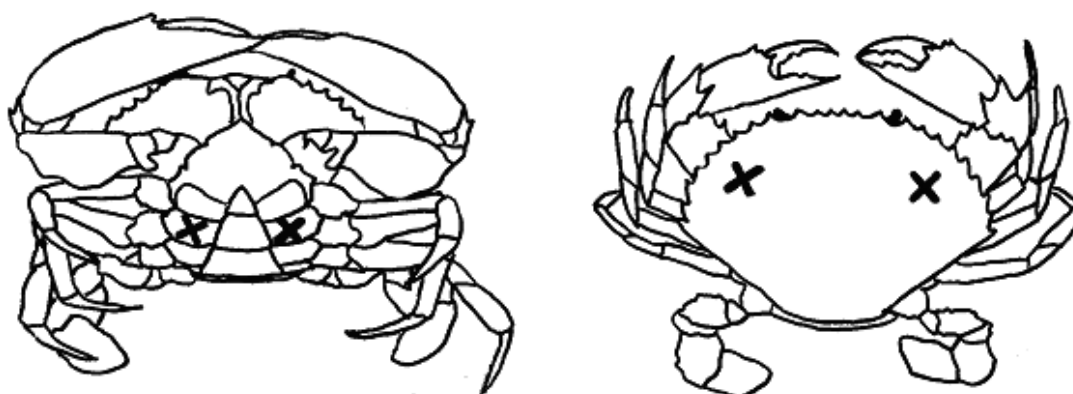

Figure 6.3. Position of moult index test sites on male (left) and female (right) *Scylla serrata*

Most mud crabs caught during this work were tagged with a 50-mm long numbered plastic T-bar tag (Type TBA-2; Hallprint, Hindmarsh Valley, South Australia) and released at the point of capture. Some crabs were retained whilst those caught during the last haul of each potting trial were not tagged. The point of this exercise was to identify unique captures during each trip rather than provide population estimates. Bycatch were identified to the lowest possible taxon and individually counted (with the exception of jellyfish where numbers were estimated).

6.2.4 Supplementary data - weight at width relationships for *Scylla serrata* caught by commercial fishers in the Roper River

The Fisheries Division of DPIF has conducted routine biological monitoring of the NT commercial mud crab fishery catch since 1992 (Hay and Calogeras, 2000). Between 100 and 200 mud crabs, contingent on availability, are sampled from several systems (including the Roper River) on a monthly basis once the catch has been transported to Darwin (prior to re-packing and air-freighting to interstate markets).

Sex, CW, wet weight, moult stage, chela propodus height (the largest vertical propodus dimension, excluding spines), mating scars (males only), limb loss and any shell damage or parasitic infections are recorded for each crab on a customised Microsoft Access 2007 database, which as of March 2012 contained records on almost 69 000 individual mud crabs.

The database contains many records of under-sized crabs because the MLSs for the fishery have increased (by 10 mm for males and 20 mm for females) since monitoring began. Measurements from under-sized crabs have also been collected through a combination of occasional on-board catch monitoring and special permits to retain under-sized crabs for research purposes.

Wet weight (WW; y) data for live, unparasitised, male and female *S. serrata* sampled from the catch of commercial fishers operating in and around the Roper River were plotted against CW (x) and the equations for the relationships were used to derive WW estimates from CW measures taken from crabs caught in wire-mesh pots set in the Roper River (this study).

6.2.5 Data analyses

Comparisons of sex ratio, carapace width and catch rates

Chi-squared (χ^2) tests were used to determine if the sex ratio of crabs caught in different escape vent treatments or seasons differed from parity. One-way analysis of variance (ANOVA) was employed to test for significant differences in mean CW between escape vent treatments for under-sized and legal-sized crabs of each sex. The catch of under-sized and legal-sized crabs in each pot-lift across the different escape vent treatments was compared using Mann-Whitney *U*-tests. The overall catch per unit effort (CPUE) of crabs in each treatment relative to that of the control group was termed “catch relative to control” (or CRC) and is given by:

$$CRC = \frac{CPUE_{treatment}}{CPUE_{control}} - 1 \quad \text{Equation 1}$$

with negative CRC values indicating a reduction in the CPUE relative to the control group and positive CRC values indicating an increase in the CPUE relative to the control.

Significance tests for sex ratio and CW data were performed using Microsoft™ Excel 2010 (Redmond, Virginia, USA) while Mann-Whitney *U*-tests were executed in Statistica 10 (Statsoft®, Tulsa, Oklahoma, USA).

SELECT modelling of catch data

Parameter estimates for the size-selectivity curves for each experimental treatment were calculated using the SELECT (Share Each Length-class's Catch Total) modelling method. This technique uses data from experiments where fishing gear with unknown size-selectivity properties (in this case pots with escape vents) is fished with a control gear (unvented pots) that is assumed to retain all size classes (be it length, width or otherwise) of the target species that encounter the gear (Treble et al., 1998).

The SELECT method models the proportion of the total catch in each size class (experimental and control combined) caught in the experimental fishing gear, to produce a size-selectivity curve for that gear. For each size class of individual, l , the proportion of the total catch caught in the experimental gear $\phi(l)$, is given by:

$$\phi(l) = \frac{p \cdot r(l)}{p \cdot r(l) + (1 - p)} \quad \text{Equation 2}$$

The size-selectivity function $r(l)$ describes the probability of retention of animals of length l in the experimental gear given that they encountered this gear, whilst the “split” parameter p describes any possible differences in the intensities with which the data from the experimental and control gears are collected. The SELECT model is fitted to the observed data using a maximum likelihood estimation procedure.

Two different size-selectivity functions were used in the SELECT modelling of the data from the experimental treatments applied here: a symmetrical logistic function and an asymmetrical Richards function (Richards, 1959). The logistic size-selectivity function is given by:

$$r(l) = \frac{e^{(a+b \cdot l)}}{1 + e^{(a+b \cdot l)}} \quad \text{Equation 3}$$

where $a < 0$ and $b > 0$. The asymmetrical Richards' function is a generalisation of the logistic model, and is given by:

$$r(l) = \left(\frac{e^{(a+b \cdot l)}}{1 + e^{(a+b \cdot l)}} \right)^{\frac{1}{\delta}} \quad \text{Equation 4}$$

The additional parameter δ defines the amount and direction of asymmetry in the size-selection curve, with $\delta > 1$ yielding a longer tail to the left of l_{50} (the size at 50% retention) and $0 < \delta < 1$ yielding a longer tail to the right of l_{50} . The logistic model being a special case of the Richards' function, where $\delta = 1$. According to these models, L_{50} and the selection range ($SR = l_{75} - l_{25}$) are defined as follows (from Groeneveld et al., 2005):

$$L_{50} = \frac{\ln\left(\frac{0.5^{\delta}}{1 - 0.5^{\delta}}\right) - a}{b}, \text{ simplifying to } L_{50} = -\frac{a}{b} \text{ when } \delta = 1 \quad \text{Equation 5}$$

and

$$SR = \frac{\ln\left(\frac{0.75^{\delta}}{1 - 0.75^{\delta}}\right) - \ln\left(\frac{0.25^{\delta}}{1 - 0.25^{\delta}}\right)}{b}, \text{ simplifying to } SR = \frac{2 \ln 3}{b} \text{ when } \delta = 1. \quad \text{Equation 6}$$

As mentioned above, the parameter p (in Equation 2) describes possible differences in the intensity of data collection between control and experimental gears. The factors that contribute to these differences include (i) relative fishing effort, (ii) relative fishing efficiency, and (iii) relative sampling effort (Xu and Miller, 1993).

In this study, relative sampling effort was equal between control and experimental gears as all crabs captured were measured. Hence, this factor had no effect on the value of p here and will not be discussed further.

By contrast, the relative fishing effort was unbalanced because the number of successful pot-lifts (referred to as effective effort in subsequent sections) differed between vented (experimental) and unvented (control) pots. The relative fishing effort for these gear types is commonly expressed as f_1 and f_2 , respectively. Using an example where the number of successful pot-lifts for the experimental gear was 60 and that for the control gear 40, and assuming for convenience that f_1 and f_2 sum to unity, then $f_1 = 60/100 = 0.6$ and $f_2 = 40/100 = 0.4$.

If the control and experimental gears are assumed to have the same fishing efficiency (aka fishing power) then p will be equal to the proportion of effective effort for the experimental gear (f_1 , or 0.6 in this example). However, if the two gear types have unequal fishing efficiency, p will have some other value, which can be estimated by the SELECT procedure (Treble et al., 1998).

Once the model that best fits the data (p estimated or $p = f_1$) is determined (using Akaike's Information Criterion [AIC]) it is then possible to calculate the relative fishing efficiency of the experimental and control gears (expressed as c_1 and c_2 , respectively). The AIC is a measure of the goodness of fit of the model, with lower values indicating a better fit to the data.

All SELECT modelling (performed using MATLAB® R2012a, The MathWorks, Inc., Natick, Massachusetts, USA) was based on 5-mm CW size classes (60 to 64 mm, 65 to 69 mm, 70 to 74 mm, etc.) covering the entire size range for each size frequency distribution. The 5 mm CW size classes were also used to ensure consistency across models, and to balance data resolution against the number of size classes expected to have either zero catch or zero escapement (Millar and Fryer, 1999).

6.3 RESULTS

6.3.1 General catch statistics

A total of 694 mud crabs (all *S. serrata*) were caught from 1471 pot-lifts on the Roper River (Table 6.2). Two crabs were infected with the parasite *L. ihlei* and one was found dead inside a pot, presumably the victim of cannibalism. Fourteen individuals of each sex were recaptured, but only within the same season as they were tagged. One male and one female were recaptured twice. The recapture rate differed between seasons, being highest in the build-up (5.4%; including two double recaptures) followed by the run-off (4.7%) and the dry season (0.1%). The overall incidence of recaptures was 4.3%

Table 6.2. Fishing effort (pot-lifts), total catch, unique catch (excluding recaptures, dead or parasitised animals), effective effort (number of pot-lifts that caught one or more unique crabs) and significance tests for catch by sex (based on unique catch) of *Scylla serrata* sampled from the Roper River relative to experimental group. Chi-squared (χ^2) values calculated using one degree of freedom.

Group	Fishing effort	Total catch	Unique catch	Effective effort	Males	Females	χ^2	p
Control	212	109 ^a	104	76	49	55	0.35	0.56
1x46mm	209	93	90	72	42	48	0.40	0.53
2x46mm{diag}	211	96 ^b	92	76	38	54	2.78	0.10
2x46mm{opp}	204	120	116	89	48	68	3.45	0.06
2x46mm{same}	214	119	115	86	48	67	3.14	0.08
3x46mm	212	85 ^a	77	63	32	45	2.19	0.14
4x46mm	209	72	67	55	28	39	1.81	0.18
Total	1471	694	661	517	285	376	-	-

^a one crab infected with the parasite *Loxothylacus ihlei*

^b one crab dead, presumed victim of cannibalism

Effective effort (number of pot-lifts that caught one or more unique crabs) as a proportion of total fishing effort was lowest for the 4x46mm treatment (at 26%; using data from Table 6.2) and highest for the 2x46mm{opp} treatment (at 44%). When the data were analysed by season (using data from Table 6.3), effective effort was lowest in the dry season (at 28%) and highest in the build-up (at 43%).

The number of unique male and female *S. serrata* caught in the control and treatment groups was not significantly different from parity (Table 6.2). However, the sex ratio of the catch was significantly biased ($p < 0.05$) towards females during the build-up and males during the run-off (Table 6.3). No ovigerous females were captured.

The proportion of soft (recently-moulted) male crabs in the catch decreased from 37% in the dry season, to 22% in the build-up, to 10% in the run-off. The pattern for soft female crabs was the reverse, increasing from 16%, to 23%, to 36% for corresponding seasons. The overall incidence of soft crabs was 21%.

Table 6.3. Fishing effort (pot-lifts), total catch, unique catch (excluding recaptures, dead or parasitised animals), effective effort (number of pot-lifts that caught one or more unique crabs) and significance tests for catch by sex (based on unique catch) of *Scylla serrata* sampled from the Roper River relative to season. Chi-squared (χ^2) values calculated using one degree of freedom.

Season	Fishing effort	Total catch	Unique catch	Effective effort	Males	Females	χ^2	<i>p</i>
Dry	379	134 ^a	132	105	59	73	1.48	0.223
Build-up	548	350 ^a	330	236	55	275	146.67	<0.001
Run-off	544	210 ^b	199	176	171	28	102.76	<0.001
Total	1471	694	661	517	285	376	–	–

^a one crab infected with the parasite *Loxothylacus ihlei*

^b one crab dead, presumed victim of cannibalism

Males ranged in size from 82 to 184 mm CW whilst females ranged from 100 to 182 mm CW (Figure 6.4). The relative size frequency distributions for both sexes were unimodal, although the distribution of male sizes was “flatter” than that of females (noting that data were pooled across seasons and treatment groups). The curve describing the female size distribution was a better fit than that for males (see Appendix 3). There was no significant difference in the mean CW of males (141 mm) and females (143 mm) caught in wire-mesh pots set in the Roper River (one-way ANOVA; $F_{1,659} = 3.027$, $p = 0.082$).

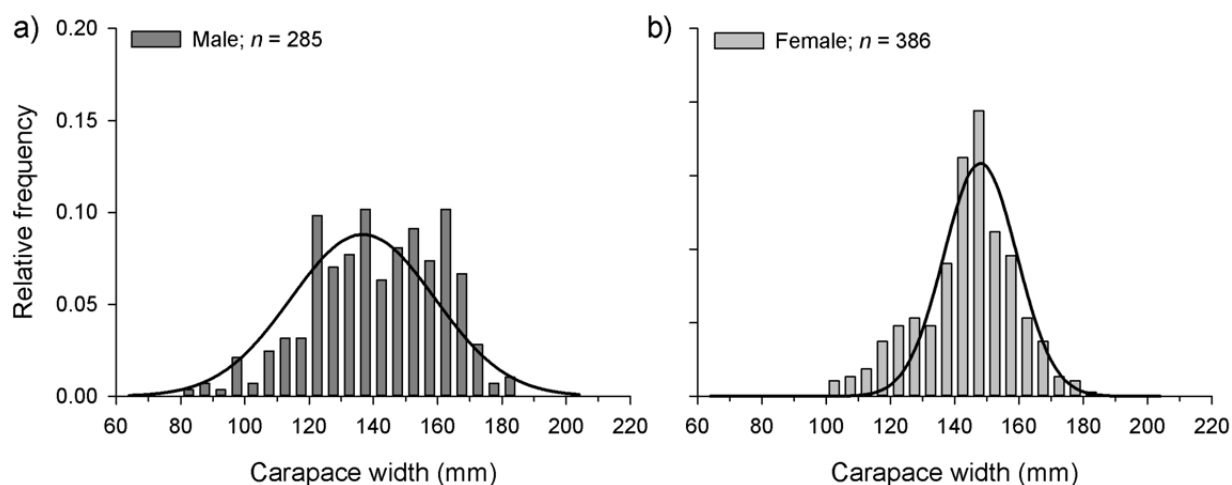

Figure 6.4. Relative size frequency of unique male a) and female b) *Scylla serrata* caught in wire-mesh pots set in the Roper River. Upper bin values for each 5-mm size category end with 4 or 9. Parameter values and correlations coefficients for Gaussian curves are given in Appendix 3.

6.3.2 Supplementary data - weight at width relationships for *Scylla serrata* caught by commercial fishers in the Roper River

The CW and WW of male *S. serrata* ($n = 8181$) sampled from the catch of commercial mud crab fishers operating in and around the Roper River ranged from 108 to 196 mm and 220 to 1851 g, respectively. Corresponding figures for females ($n = 10\,525$) were 111 to 200 mm CW and 195 to 1261 g, respectively.

The relationships between CW and WW for males and females differed and are shown in Figure 6.5. The greater slope of the relationship for males is due to the allometric growth of the chelae, which begins when the animal reaches about 130 mm CW (Knuckey, 1999). Some of the variability in WW for a given CW is due to the inclusion of crabs in different moult stages as well as those missing one or more appendages.

The equations $y = 0.000008x^{3.665}$ and $y = 0.0002x^{2.979}$ were used to estimate WW (x) from CW (y) for each of the 285 unique male and 376 unique female mud crabs, respectively. These values were then summed for each of the different escape vent treatments and size categories examined (see next section).

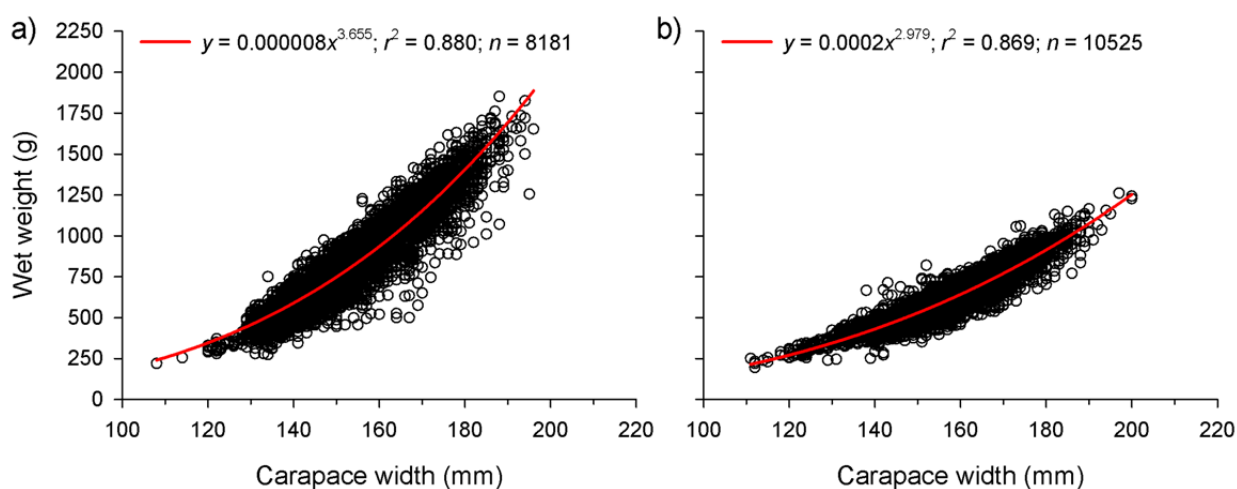

Figure 6.5. Relationships between carapace width and wet weight for a) male and b) female *Scylla serrata* sampled from the catch of commercial fishers operating in the Roper River

6.3.3 Analysis of catch rates for control and 46 mm vented wire-mesh pots where the lesser (male) minimum legal size is 140 mm carapace width

This subsection analyses catch statistics for *S. serrata* caught in wire-mesh pots (fitted with different numbers of 46 mm escape vents) and separated into one of two size brackets as per the current MLSs for the NT commercial mud crab fishery. Hence, for the purposes of this section, the term “under-sized” refers to males <140 mm CW and females <150 mm CW. Likewise, the term “legal-sized” refers to males ≥ 140 mm CW and female ≥ 150 mm CW.

Catch rates of unique *S. serrata* in different size categories (pooled across season) showed variable responses with respect to sex and escape vent treatment (Table 6.4). The CRC of under-sized crabs (pooled across sexes) in the different treatment pots ranged from -49% to +2%, with the 2x46mm{same} treatment being the only group to yield a higher catch rate of under-sized crabs than the control group. The total estimated WW (ΣWW) of under-sized crabs caught in both the 2x46mm{same} and 2x46mm{opp} treatments exceeded that of control pots. Only the 4x46mm treatment produced a statistically significant reduction in the catch rate of under-sized crabs relative to the control group.

The CRC of legal-sized *S. serrata* (pooled across sexes) ranged from -28% to +59%. Both the CRC and the total estimated WW of legal-sized crabs caught by 3x46mm and 4x46mm treatments was below that for the

control group, suggesting that the use of any more than two escape vents may have a detrimental impact on the yield of legal-sized crabs. The CRC of legal-sized crabs for the 2x46mm{diag} treatment was also negative, but this was offset by the larger mean size (and weight) of the legal-sized crabs caught in these pots, such that the total estimated WW for this group was just above that for the control pots.

Examination of the data for each sex revealed that all escape vent treatments decreased the CRC of under-sized male crabs whereas two of the six treatments (2x46mm{same} and 2x46mm{opp}) increased the CRC of under-sized females. Hence, the decrease in catch rates of under-sized crabs in vented pots set in the Roper River was primarily driven by the escape of small males. Patterns in the total estimated WW of under-sized crabs for each sex and treatment were similar to those for the CRC. There were no significant differences in mean CW of under-sized male or female crabs caught in control or treatment pots (one-way ANOVA; male CW, $F_{6,129} = 1.348$, $p = 0.241$; female CW, $F_{6,247} = 0.784$, $p = 0.583$).

Five of the six treatments produced positive CRC values for legal-sized females whereas only two of the six treatments resulted in positive CRC values for legal-sized males. Thus it appears that the increase in the CRC of legal-sized crabs in vented pots set in the Roper River was driven by the increased capture of large females. Patterns in the total estimated WW of legal-sized crabs for each sex and treatment were similar to those for the CRC. There were no significant differences in mean CW of legal-sized male or female crabs caught in control or treatment pots (one-way ANOVA; male CW, $F_{6,142} = 1.622$, $p = 0.145$; female CW, $F_{6,115} = 0.727$, $p = 0.629$).

Separate analyses of the data for each season (run-off, dry and build-up; data not shown) found no significant differences in catch rates of under-sized or legal-sized *S. serrata* between the vented and unvented (control) pots.

Using the total estimated WW of legal-sized crabs caught in unvented wire-mesh pots set in the Roper River (28.1 kg; Table 6.4) and the number of corresponding pot-lifts ($n = 212$; Table 6.2), the CPUE (by weight) of this group of crabs in the aforementioned pot type was 0.13 kg/pot-lift.

Table 6.4. Catch, mean size, total estimated weight and catch rate statistics for unique male (♂) and female (♀) *Scylla serrata* in different size categories (reflecting current minimum legal sizes for the NT commercial fishery) caught in vented and unvented (control) wire-mesh pots set in the Roper River. See Table 6.2 for the number of pot-lifts per group. Threshold significance level = 0.0083 (Bonferroni *p*-value for 6 individual tests at 5% level).

Sex/size category (mm) and pot group	No. crabs ^a	Mean carapace width (mm) ^b	s.e.	Σ wet weight (kg)	Mean CPUE ^c	s.e.	Catch relative to control ^d	U-statistic	<i>p</i> -value
♂ <140; ♀ <150									
Control	68	127.7	1.7	26.70	0.321	0.043	-	-	-
1x46mm	48	133.3	1.9	21.35	0.230	0.032	-28%	21116	0.256
2x46mm{diag}	58	132.4	1.6	25.40	0.275	0.041	-14%	21740	0.502
2x46mm{opp}	61	134.1	1.5	27.52	0.299	0.041	-7%	21455	0.855
2x46mm{same}	70	129.7	1.8	29.05	0.327	0.041	2%	22349	0.730
3x46mm	51	132.0	2.0	22.20	0.241	0.036	-25%	21391	0.241
4x46mm	34	133.6	2.2	15.35	0.163	0.030	-49%	19697	0.004
♂ ≥140; ♀ ≥150									
Control	36	155.9	1.5	28.10	0.170	0.029	-	-	-
1x46mm	42	158.7	1.7	35.34	0.201	0.033	18%	21598	0.488
2x46mm{diag}	34	160.2	1.3	28.62	0.161	0.029	-5%	22160	0.790
2x46mm{opp}	55	156.6	0.9	42.83	0.270	0.037	59%	19872	0.034
2x46mm{same}	45	156.2	1.3	33.89	0.210	0.030	24%	21692	0.235
3x46mm	26	155.8	1.7	20.17	0.123	0.024	-28%	21696	0.300
4x46mm	33	157.9	1.7	26.11	0.158	0.028	-7%	21978	0.819
♂ <140									
Control	27	119.9	2.3	8.92	0.127	0.025	-	-	-
1x46mm	14	122.2	4.1	5.08	0.067	0.017	-47%	21012	0.069
2x46mm{diag}	21	126.8	2.3	8.41	0.100	0.023	-22%	21749	0.354
2x46mm{opp}	18	125.8	2.3	6.99	0.088	0.020	-31%	20964	0.308
2x46mm{same}	27	121.1	2.7	9.41	0.126	0.025	-1%	22567	0.868
3x46mm	17	123.4	3.6	6.35	0.080	0.020	-37%	21515	0.139
4x46mm	12	129.2	2.5	5.09	0.057	0.016	-55%	20802	0.027
♂ ≥140									
Control	22	155.3	2.2	18.35	0.104	0.023	-	-	-
1x46mm	28	157.8	2.1	24.82	0.134	0.026	29%	21503	0.335
2x46mm{diag}	17	162.1	2.2	16.46	0.081	0.019	-22%	22041	0.598
2x46mm{opp}	30	156.2	1.5	25.32	0.147	0.027	42%	20704	0.176
2x46mm{same}	21	152.7	1.9	16.37	0.098	0.020	-5%	22619	0.921
3x46mm	15	155.7	2.8	12.63	0.071	0.019	-32%	21832	0.281
4x46mm	16	156.4	2.4	13.63	0.077	0.021	-26%	21554	0.310
♀ <150									
Control	41	132.8	1.9	17.78	0.193	0.034	-	-	-
1x46mm	34	137.9	1.6	16.27	0.163	0.028	-16%	22092	0.936
2x46mm{diag}	37	135.6	1.9	16.99	0.175	0.032	-10%	22299	0.931
2x46mm{opp}	43	137.5	1.7	20.53	0.211	0.037	8%	21319	0.692
2x46mm{same}	43	135.1	2.0	19.64	0.201	0.033	3%	22257	0.595
3x46mm	34	136.3	2.0	15.85	0.160	0.029	-17%	22268	0.791
4x46mm	22	136.0	3.0	10.26	0.105	0.024	-46%	20880	0.069
♀ ≥150									
Control	14	156.8	1.8	9.75	0.066	0.020	-	-	-
1x46mm	14	160.5	2.7	10.52	0.067	0.019	1%	22037	0.820
2x46mm{diag}	17	158.2	1.5	12.16	0.081	0.024	22%	22248	0.819
2x46mm{opp}	25	157.2	1.0	17.51	0.123	0.025	86%	20424	0.041
2x46mm{same}	24	159.3	1.4	17.52	0.112	0.024	70%	21646	0.082
3x46mm	11	156.1	1.5	7.54	0.052	0.015	-21%	22355	0.814
4x46mm	17	159.3	2.3	12.48	0.081	0.019	23%	21623	0.333

^a values in bold referred to in Table 9.2

^c Catch per unit effort (CPUE) as crabs per pot-lift

^b values in bold referred to in Table 9.1

^d values in bold averaged across treatments for under-sized and legal-sized crabs and shown in Tables 9.3 and 9.5, respectively

6.3.4 *SELECT* modelling of data from wire-mesh pots

Based on the ranked values of Akaike's Information Criterion (AIC), the Richards' function with unequal fishing efficiency (estimated p) was the most parsimonious fit to the pooled sex data for three of the six escape vent treatments (Table 6.5). However, the logistic function with equal fishing efficiency was the better fit to the pooled sex data in the other three treatments (Table 6.5) and the vast majority (11 of 12) of cases where the data for each sex was modelled separately (Tables 6.6 and 6.7).

Whilst the latter function was considered the best fit to the data for this particular data set, *SELECT* modelling using the logistic curve did, on occasion, produce unrealistic estimates of L_{50} and the selection range (SR), as did all other curves fitted. Attempts to derive more realistic values by increasing the breadth of the size categories used (from 5 mm to 10 mm – thereby increasing the sample size within each size category) were unsuccessful. The model, created in Matlab, uses the "fminsearch" function, which finds the minimum of a scalar function of several variables, starting at an initial estimate. The fitting procedure works well as long as consecutive size classes contain regular, non-zero values that are not widely divergent. Problems in the model fitting appear to be due to irregular and highly divergent data (oscillating between 0% and 100%) which led to errors and a nonsensical model output.

When the logistic function was applied to the pooled sex data, the four "realistic" estimates of size at 50% retention (L_{50}) ranged from 113 to 119 mm CW (Figure 6.6), with smaller values indicating more retention and larger values indicating more escape. Corresponding figures for males (from four "realistic" curves) and females (from five "realistic" curves) were 108 to 118 mm CW (Figure 6.7) and 117 to 127 mm CW (Figure 6.8), respectively. There was no apparent relationship between L_{50} estimates and the number of escape vents fitted.

Although the logistic curve with equal fishing efficiency was the best fit to the data in almost all cases, it is premature to assume that there was no difference in fishing efficiency between vented and unvented wire-mesh pots. Differences in the value of p under equal and unequal fishing efficiency can be identified by comparing the estimated and fixed values of this parameter. Here we will compare the values derived from modelling the two types of Richards' curves as the logistic curve with unequal fishing efficiency was often the worst fit to the data.

SELECT modelling of the pooled sex data predicted a slight increase in fishing efficiency for five of the six escape vent treatments (and no difference for the remaining treatment – 2x42mm{same}) relative to unvented control pots (Table 6.5). When applied to the data for males only, the *SELECT* model predicted a larger increase in fishing efficiency for the same five treatments but again no change for the 2x42mm{same} treatment (Table 6.6). Results for females (Table 6.7) were mixed, with the model predicting a slight increase in fishing efficiency for two treatments (2x42mm{diag} and 2x42mm{opp}), no change for two others (1x42mm and 3x42mm) and a small decrease for the remainder (2x42mm{same} and 4x42mm).

Table 6.5. Results of SELECT modelling on the catch of *Scylla serrata* (sexes pooled) in wire-mesh pots fitted with different numbers and configurations of 46 mm escape vents. The Akaike's Information Criterion (AIC) value was used to rank the different models in order of the most parsimonious fit.

Treatment	Curve	p eq1	Parameter estimates				L_{50}	SR	AIC	Rank
			p	a	b	δ				
1x46mm	Logistic	0.49 ¹	-	-7.60	0.66	1	115.5	33.4	66.63	3
	Logistic	-	0.47	-510	55.7	1	91.5	0.39	72.25	4
	Richards'	0.49 ¹	-	-1204	85.1	244	121.7	31.4	65.89	2
	Richards'	-	0.54	-1192	82.7	209	126.5	27.8	64.67	1
2x46mm{diag}	Logistic	0.50 ²	-	-8.1	0.72	1	112.5	30.3	64.94	1
	Logistic	-	0.47	-534	56.8	1	94.2	0.39	69.38	4
	Richards'	0.50 ²	-	-1221	88.1	256	117.6	37.1	65.45	3
	Richards'	-	0.52	-1220	87.9	237	120.1	29.6	65.19	2
2x46mm{opp}	Logistic	0.54 ³	-	-12.7	1.07	1	118.9	20.5	68.78	3
	Logistic	-	0.67	-8.48	0.62	1	136.6	35.4	67.19	2
	Richards'	0.54 ³	-	-1218	87.5	203	123.0	25.5	69.29	4
	Richards'	-	0.60	-765	54.0	108	127.7	22.1	67.07	1
2x46mm{same}	Logistic	0.53 ⁴	-	-472	53.2	1	88.6	0.41	65.42	1
	Logistic	-	0.53	-472	53.3	1	88.6	0.41	67.40	=2
	Richards'	0.53 ⁴	-	-528	56.0	127	76.8	24.8	68.34	3
	Richards'	-	0.53	-501	55.0	119	76.2	23.7	67.40	=2
3x46mm	Logistic	0.45 ⁵	-	-3.91	0.43	1	92.0	51.7	62.73	1
	Logistic	-	0.53	-3.06	0.27	1	115.4	82.8	64.40	4
	Richards'	0.45 ⁵	-	-1217	87.3	432	105.1	54.3	63.59	3
	Richards'	-	0.46	-1216	87.1	411	106.8	51.9	63.57	2
4x46mm	Logistic	0.42 ⁶	-	-9.27	0.78	1	119.1	28.2	65.01	3
	Logistic	-	0.40	-614.	60.5	1	101.6	0.36	70.47	4
	Richards'	0.42 ⁶	-	-1218	87.5	193	123.9	24.2	64.67	2
	Richards'	-	0.46	-1215	87.0	166	126.4	21.0	63.93	1

¹ $p = 72/148$; ² $p = 76/152$; ³ $p = 89/165$; ⁴ $p = 86/162$; ⁵ $p = 63/139$; ⁶ $p = 55/131$

Table 6.6. Results of SELECT modelling on the catch of male *Scylla serrata* in wire-mesh pots fitted with different numbers and configurations of 46 mm escape vents. The Akaike's Information Criterion (AIC) value was used to rank the different models in order of the most parsimonious fit.

Treatment	Curve	p eq1	Parameter estimates				L_{50}	SR	AIC	Rank
			p	a	b	δ				
1x46mm	Logistic	0.45 ¹	-	-5.37	0.53	1	100.6	41.2	55.08	2
	Logistic	-	0.47	-510	55.7	1	91.5	0.39	57.00	4
	Richards	0.45 ¹	-	-1169	78.4	450	109.3	63.0	55.87	3
	Richards	-	0.72	-677	35.6	152	160.8	46.9	52.95	1
2x46mm{diag}	Logistic	0.44 ²	-	-9.51	0.90	1	105.3	24.3	55.07	1
	Logistic	-	0.44	-531	56.4	1	94.2	0.39	57.36	4
	Richards	0.44 ²	-	-1119	83.5	276	111.1	36.3	56.49	3
	Richards	-	0.49	-1139	84.4	218	117.0	28.4	55.85	2
2x46mm{opp}	Logistic	0.50 ³	-	-13.9	1.21	1	115.3	18.2	51.18	1
	Logistic	-	0.51	-665	61.3	1	108.5	0.36	53.42	4
	Richards	0.50 ³	-	-1219	87.7	241	120.0	30.2	53.13	3
	Richards	-	0.58	-1217	87.3	172	125.6	21.7	51.50	2
2x46mm{same}	Logistic	0.49 ⁴	-	-75	12.1	1	61.8	1.81	48.07	1
	Logistic	-	0.49	-205	29.5	1	69.7	0.75	50.02	=2
	Richards	0.49 ⁴	-	-426	51.6	52.3	75.6	11.1	50.03	3
	Richards	-	0.49	-441	52.5	54.1	77.0	11.3	50.02	=2
3x46mm	Logistic	0.39 ⁵	-	-373	48.9	1	76.3	0.45	52.15	1
	Logistic	-	0.40	-394	49.8	1	79.2	0.44	54.14	4
	Richards	0.39 ⁵	-	-1218	87.6	952	63.7	0.01	53.79	3
	Richards	-	0.42	-1217	87.6	608	91.0	0.01	53.56	2
4x46mm	Logistic	0.37 ⁶	-	-22.5	1.9	1	118.4	11.6	44.17	1
	Logistic	-	0.45	-16.9	1.4	1	125.0	16.2	44.92	3
	Richards	0.37 ⁶	-	-1220	88.0	179	124.5	22.3	46.23	4
	Richards	-	0.47	-1219	87.8	114	130.0	14.3	44.39	2

¹ $p = 37/82$; ² $p = 35/80$; ³ $p = 45/90$; ⁴ $p = 43/88$; ⁵ $p = 29/74$; ⁶ $p = 26/71$

Table 6.7. Results of SELECT modelling on the catch of female *Scylla serrata* in wire-mesh pots fitted with different numbers and configurations of 46 mm escape vents. The Akaike's Information Criterion (AIC) value was used to rank the different models in order of the most parsimonious fit.

Treatment	Curve	ρ eq1	Parameter estimates				L_{50}	SR	AIC	Rank
			ρ	a	b	δ				
1x46mm	Logistic	0.53 ¹	-	-18.9	1.49	1	127.0	14.8	46.43	1
	Logistic	-	0.54	-18.3	1.43	1	127.7	15.4	48.41	4
	Richards	0.53 ¹	-	-1219	87.7	117	129.7	14.7	47.57	3
	Richards	-	0.53	-1219	87.7	116	129.8	14.5	47.56	2
2x46mm{diag}	Logistic	0.53 ²	-	-7.86	0.68	1	115.6	32.3	47.86	1
	Logistic	-	0.50	-103	12.3	1	84.1	1.79	51.40	4
	Richards	0.53 ²	-	-1218	87.7	232	120.6	29.1	49.00	3
	Richards	-	0.54	-1218	87.6	222	121.5	27.8	48.98	2
2x46mm{opp}	Logistic	0.58 ³	-	-12.2	1.00	1	122.6	22.1	50.72	1
	Logistic	-	0.76	-7.47	0.49	1	151.2	44.5	51.01	=2
	Richards	0.58 ³	-	-1210	86.2	181	125.9	23.1	51.53	3
	Richards	-	0.62	-1194	83.2	172	129.3	22.7	51.01	=2
2x46mm{same}	Logistic	0.56 ⁴	-	-4.46	0.46	1	96.5	47.5	51.14	1
	Logistic	-	0.55	-497	51.8	1	95.8	0.42	53.89	=3
	Richards	0.56 ⁴	-	-1191	82.6	438	107.4	58.3	52.31	2
	Richards	-	0.55	-589	59.3	110	86.5	20.3	53.89	=3
3x46mm	Logistic	0.50 ⁵	-	-9.08	0.78	1	116.4	28.2	43.16	1
	Logistic	-	0.50	-9.18	0.79	1	116.3	27.8	45.16	4
	Richards	0.50 ⁵	-	-1193	83.0	307	118.1	40.6	44.82	3
	Richards	-	0.50	-1193	83.1	328	116.3	43.3	44.80	2
4x46mm	Logistic	0.46 ⁶	-	-5.67	0.49	1	116.8	45.2	52.93	1
	Logistic	-	0.42	-523	52.9	1	99.1	0.41	56.71	=3
	Richards	0.46 ⁶	-	-1129	71.1	363	123.4	56.0	53.64	2
	Richards	-	0.42	-512	53.9	107	81.1	21.8	56.71	=3

¹ $\rho = 43/81$; ² $\rho = 43/81$; ³ $\rho = 52/90$; ⁴ $\rho = 48/86$; ⁵ $\rho = 38/76$; ⁶ $\rho = 32/70$

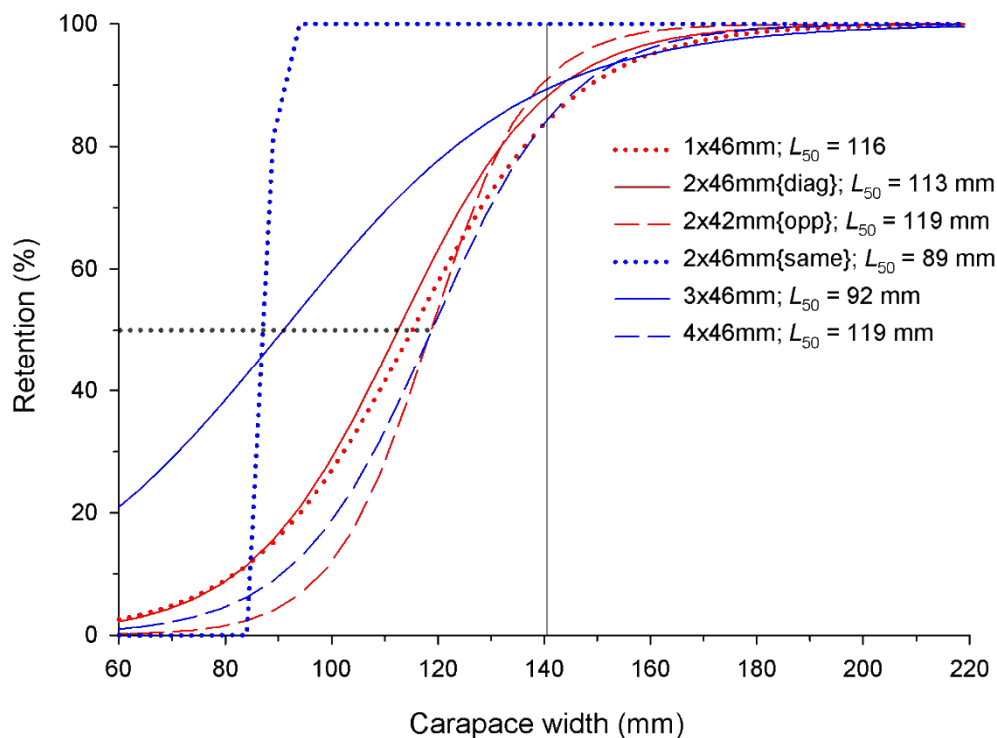

Figure 6.6. Logistic selectivity curves for *Scylla serrata* (pooled across sex) caught in wire-mesh pots fitted with different numbers and configurations of 46 mm escape vents. The horizontal dotted line intersects the length at 50% retention (L_{50}) for each curve. The vertical line represents the minimum legal size for male *S. serrata* harvested by the NT commercial mud crab fishery.

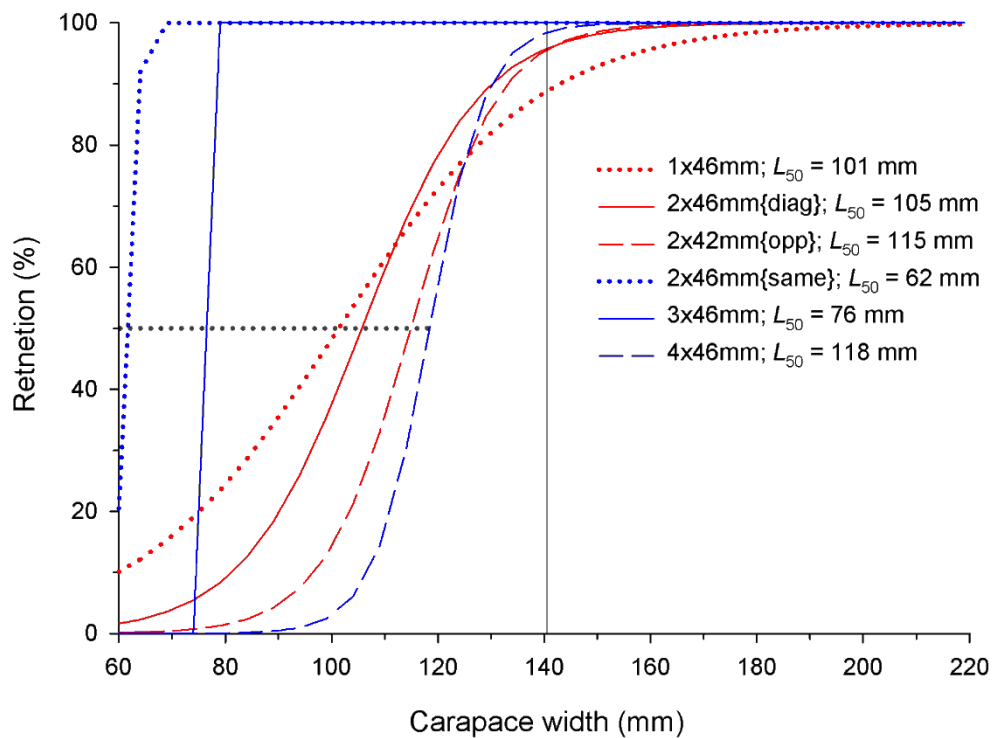

Figure 6.7. Logistic selectivity curves for male *Scylla serrata* caught in wire-mesh pots fitted with different numbers and configurations of 46 mm escape vents. The horizontal dotted line intersects the length at 50% retention (L_{50}) for each curve. The vertical line represents the minimum legal size for male *S. serrata* harvested by the NT commercial mud crab fishery.

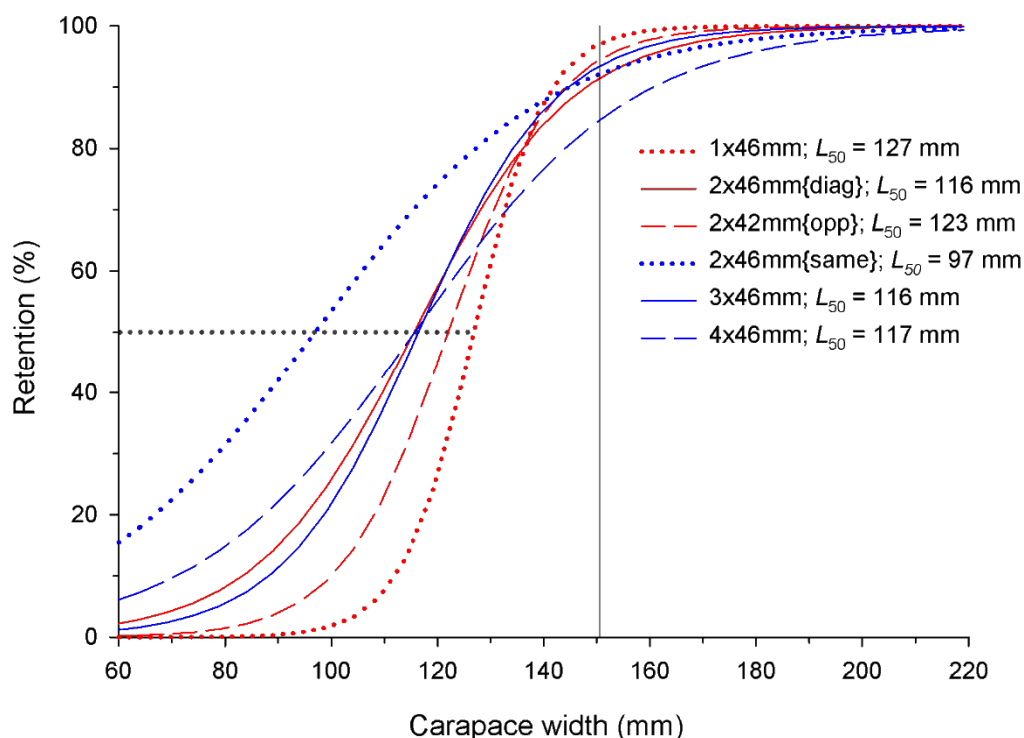

Figure 6.8. Logistic selectivity curves for female *Scylla serrata* caught in wire-mesh pots fitted with different numbers and configurations of 46 mm escape vents. The horizontal dotted line intersects the length at 50% retention (L_{50}) for each curve. The vertical line represents the minimum legal size for female *S. serrata* harvested by the NT commercial mud crab fishery.

6.3.5 Gear and bycatch summary

Overall bait retention in control pots was 94%; this figure varied from 91% to 96% in the six different treatment groups. The incidence of pot damage in each group was low, ranging from non-existent to 2%. Nineteen individual fishes from three species/groups were recorded as bycatch from 1471 pot-lifts (Table 6.8), equating to 1.29 fish/100 pot-lifts. Catfish (*Arius* spp.) were the most common piscine bycatch (17 individuals) followed by one each of Barramundi (*Lates calcarifer*) and Blue Threadfin (*Eluetheronema tetradactylum*). Approximately 100 unidentified jellyfish were also caught in wire-mesh pots.

Table 6.8. Mean incidence of bycatch in pots with different numbers of 46 mm escape vents. Data for the three groups of pots with two escape vents (in different orientations) were pooled. Figures below treatment names refer to the number of pot-lifts for that treatment where bycatch records were taken. Dash indicates species not recorded. An asterisk (*) indicates only one observation per group.

Phylum	Species	Control 212	1x46mm 209	2x46mm 629	3x46mm 212	4x46mm 209
Vertebrata	Barramundi*	-	-	-	-	<1%
	<i>Lates calcarifer</i>	-	-	-	-	<1%
	Blue Threadfin*	-	<1%	-	-	-
	<i>Eluetheronema tetradactylum</i>	-	<1%	-	-	-
	Catfish	1%	2%	1%	<1%	<1%
	<i>Arius</i> spp.	1%	2%	1%	<1%	<1%
Cnidaria	Jellyfish	-	-	13%	-	10%
	Class Scyphozoa	-	-	13%	-	10%

6.4 DISCUSSION

The catch rate of legal-sized, unique *S. serrata* in unvented wire-mesh pots set in the Roper River was 0.13 kg/pot-lift, roughly one quarter of the concurrent commercial catch rate in this area (unpublished data). Given that the recapture rate of tagged crabs in this system was only 4.3%, the inclusion of this group in the above estimate would make negligible difference. The fact that our catch rate was lower than that of commercial fishers is not unexpected given the logistical constraints on the duration of our sampling program and differences as to where the pots were set (inside the mouth of the Roper River as opposed to out on the coastal flats).

Seasonal differences in sex ratio and variable proportions of soft crabs at different times of year agree with previous observations on the fishery (Knuckey, 1999; Ward et al., 2008). Likewise, we did not expect to see ovigerous females given that Knuckey (1999) only caught three such individuals from a total of about 16 000 sampled over four years.

The proportion of small crabs (<120 mm CW) caught in unvented wire mesh pots set in the Roper River was 16% (data not shown), roughly twice the figure reported using the same style of pot in the Wearyan River (approximately 300 km to the south-east of the Roper River) by Hay et al. (2005). This difference is not considered unusual given known variations in mean CW of *S. serrata* between locations (see Chapters 7 and 8).

Bait retention was consistently high in all pot groups, ranging from 91% to 96%. Very few pots set in the Roper River (<1% overall) experienced significant damage.

The incidence of piscine bycatch in wire-mesh pots set in the Roper River (1.29 fish/100 pot-lifts) was less than half that recorded for identical pots set in the Wearyan River by Hay et al. (2005) of 2.76 fish/100 pot-lifts and the Corindi and Wooli rivers (NSW) by Butcher et al. (2012) of 2.78 fish/100 pot-lifts. Notably, the use of the same pots in the Adelaide River by Hay et al. (2005) produced a fish bycatch rate of 7.46 fish/100 pot-lifts, further illustrating a location effect on the incidence of teleost bycatch in wire mesh pots.

When the CPUE data (as crabs/pot-lift) was pooled across sex, the CRC of under-sized crabs in each of the 46 mm escape vent treatments was always less than that in the control pots (Table 6.4). However, the 3x46mm and 4x46mm treatments also produced lower catch rates and smaller catches (by weight) of legal-sized crabs, suggesting that these treatments compromised the harvest of such crabs. The 2x46mm treatment also produced a slightly lower catch rate than that of the control pots but the overall weight of the catch for this treatment was just above that of the control pots.

Analysis of the CPUE data for each sex revealed differences in the effects of fitting escape vents between males and females. The reduction in the retention of under-sized crabs was greater in males than females, which is not surprising given that the escape vents were sized to retain all crabs above the smaller of the two size limits (140 mm CW for males). By contrast, the increase in catch rate of legal-sized crabs in vented pots was generally greater for females than for males. Reasons for this observation are unclear.

Retention curves for the different 46 mm treatments derived from SELECT modelling were informative, but the model struggled to fit realistic curves in some instances. We believe that the distorted curves and unreliable estimates of L_{50} and SR were due to large oscillations in the proportion of crabs in the experimental pots experienced during the early iterations of the model. A larger sample size (of say 200 crabs for the control and each treatment group) may alleviate this problem.

Contrary to expectation, the use of a greater number of escape vents (which in theory should allow more under-sized crabs to escape) did not increase the value of L_{50} . A similar pattern was observed by Rudershausen and Turano (2009), who found no significant difference in the CPUE of under-sized blue

crabs between pots fitted with two, three or four escape vents for almost all of their three vent size and seven estuary treatments.

Estimates of L_{50} for the four “realistic” male selectivity curves obtained through SELECT modelling ranged from 101 to 118 mm, while those for the five “realistic” female curves ranged from 117 to 127 mm. All of these values are well below the L_{50} value of 138 mm CW for identical wire-mesh pots (without escape vents) derived from comparative fishing trials on the Adelaide River (Knuckey, 1999). However, it must be noted that the mean CW of crabs from the Adelaide River is (and has historically been) larger than that from the Roper River (Chapter 7; Knuckey, 1999).

Although Richards’ function with unequal fishing efficiency was not the best fit to our data, we are reluctant to discount the possibility of differential fishing efficiency between vented and unvented wire-mesh pots. Our findings with respect to fishing efficiency may simply be a function of our modest sample sizes.

Based on the weight of evidence approach specific to the NT commercial mud crab fishery, we suggest that fitting any more than two 46-mm escape vents to wire-mesh pots is unnecessary and may in fact compromise the harvest of legal-sized crabs. That said, our study was limited to just one location, with the CPUE of both under-sized and legal-sized blue crabs in vented pots known to vary between locations (Rudershausen and Turano, 2009). Clearly, a large scale industry trial across several locations is needed to more fully describe the effects of fitting different numbers of escape vents to wire-mesh pots.

7 THE EFFECT OF ESCAPE VENT SIZE ON CATCH RATES OF UNDER-SIZED AND LEGAL-SIZED GIANT MUD CRABS (*Scylla serrata*) IN PE-MESH POTS

7.1 INTRODUCTION

The use of collapsible PE-mesh pots (see Figure 2.2) has become increasingly popular among Australian mud-crab fishers over the last two decades. This gear type offers several advantages over traditional rigid, wire-mesh pots, most notably their ease of transport, light weight and relatively low cost. There are however, some disadvantages to the use of PE-mesh pots, particularly those constructed from relatively small (25 x 25 mm) mesh, as they may retain more under-sized mud crabs than do wire-mesh pots (which generally have a mesh size of 75 x 50 mm W x H). Bycatch retention may also be greater in the former pot type.

As mentioned previously, escape vents offer a possible means of decreasing the proportion of under-sized catch in crab and lobster pots (Krouse, 1978; Brown, 1982; Miller, 1990; Stevens, 1995; Guillory and Hein, 1998; Jirapunpipat et al., 2008). Likewise, these devices must be precisely sized (relative to the particular MLS) to optimise their effectiveness.

Commercial mud-crab fishers in the NT do not use PE-mesh pots because their mesh sizes do not comply with the gear controls for this sector. Hence, the efficacy of escape vents sized to retain crabs ≥ 140 mm CW (the MLS for commercially harvested males in the NT) in PE-mesh pots is not considered here. Instead, we concentrate on the utility of two types of escape vents sized to retain crabs ≥ 130 mm CW or ≥ 150 mm CW (the MLSs for recreationally harvested males in the NT and males harvested in Qld, respectively). Also note that the MLS of 130 mm CW for recreationally-harvested males in the NT approximates the MLS of 87 mm CL used in NSW (P. Butcher, pers. comm.).

The primary aim of this study was to compare catch rates of under-sized and legal-sized *S. serrata* in circular, collapsible PE-mesh pots with and without two identically sized escape vents suited to one or other of the two MLSs described above. A secondary aim was to quantify bycatch retention in control (unvented) and treatment pots.

7.2 MATERIALS AND METHODS

7.2.1 Description of gear

Eighty Crabflex 750/2 crab pots, each with two opposing 270 mm x 110 mm (W x H) elliptical funnels and wrapped in 25 mm x 25 mm knotted PE mesh ~1.5 mm twine thickness (Figure 7.1) were purchased from the manufacturer (Crabmaster Systems, Caloundra, Qld). The galvanised steel frames of these pots consisted of two 6-mm thick rings 750 mm in diameter, separated by four 4-mm thick folding arms in two interlocking pieces that could be locked out using a sliding "ball and rail" mechanism.

The height of the pots, when expanded was 240 mm. The waist of the pots was ~450 mm at the funnels and ~600 mm along the perpendicular axis (total pot volume roughly 0.06 m³). Each funnel consisted of an upper and lower hinged 1.5-mm thick polycarbonate panel (130 mm x 120 mm [W x L]) that acted as a one-way gate.

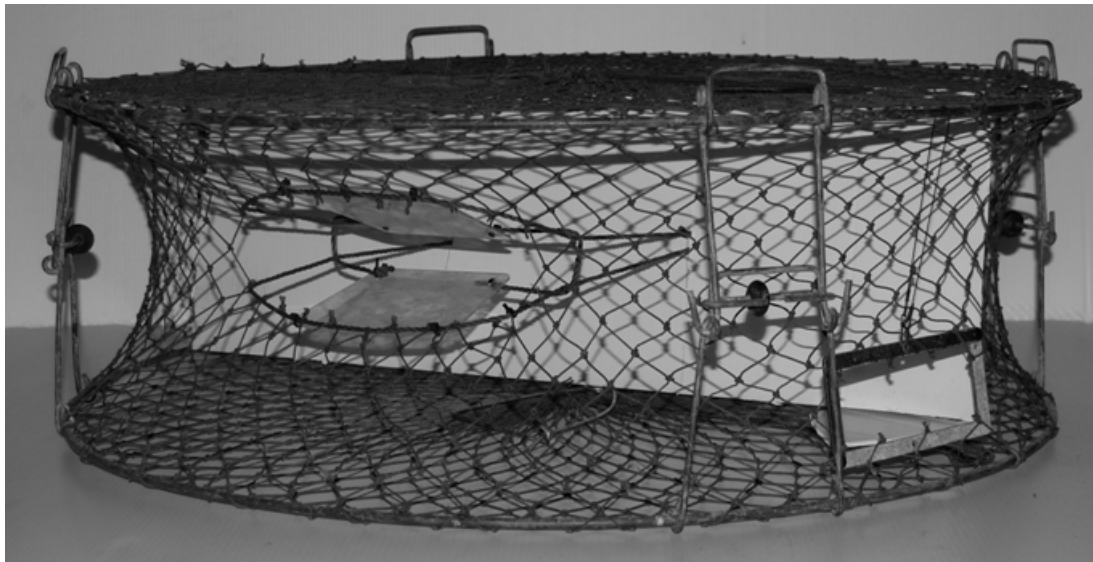

Figure 7.1. A polyethylene-mesh pot with escape vent (bottom right) fitted perpendicular to funnel (left of centre). A white plastic panel obscures the rear of the pot and was inserted to highlight design features only.

Two opposing, identically sized, escape vents were fitted to each of the 20 pots in both treatment groups just above the lower frame ring at 90 degrees to the funnels. Each vent was formed by weaving two, diagonally opposing, “L-brackets” cut from 1.6-mm thick galvanised steel plate (Figure 7.2) into the mesh, joining them with PVC push rivets through one of two holes on the short arm of the bracket, then cutting the mesh on the distal side of the knots holding the plates. Wire traces 150 mm in length were looped over the upper frame ring and both ends clipped into a hole at the centre point of the upper L-brackets to hold the escape vents vertical when the pot was expanded.

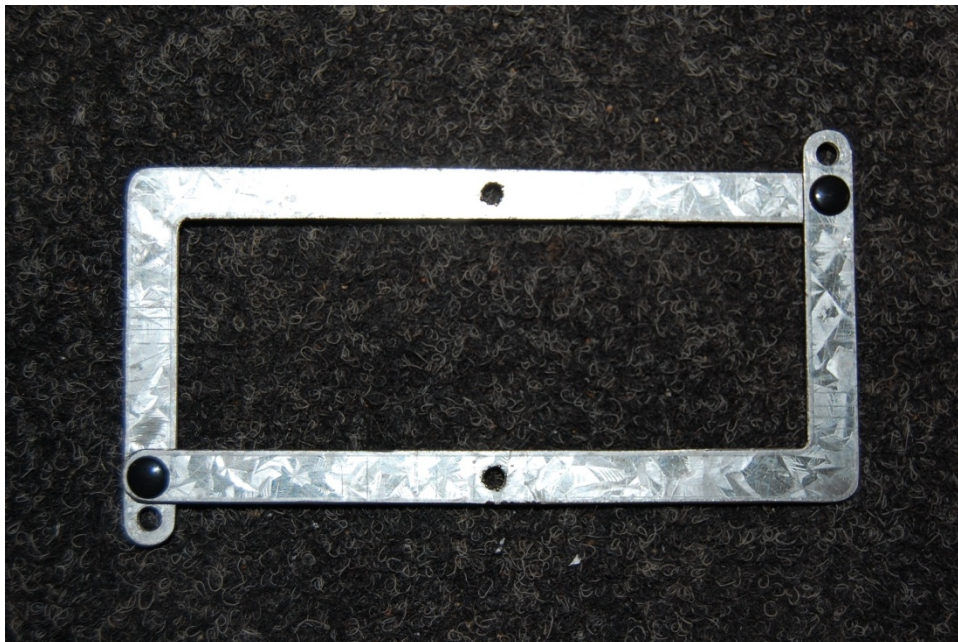

Figure 7.2. Close up of a dual sized escape vent fitted to polyethylene-mesh pots

Joining the brackets at the inner or outer holes produced an aperture of 120 mm x 42 mm (W x H) to retain crabs ≥ 130 mm CW (hereafter called the 2x42mm treatment) or 120 mm x 50 mm to retain crabs ≥ 150 mm CW (called the 2x50mm treatment), respectively. The two escape vent heights were based on values given in Table 5.3. The single escape vent width of 120 mm was used as it exceeds the maximum TL of both

130 mm CW and 150 mm CW crabs (Table 5.3) noting that the egress of crabs was limited by carapace height and not total length. The control group consisted of 20 unvented pots and the remaining 20 pots were kept as spares in case of pot loss or irreparable damage.

An 8-mm diameter, 8-m long polypropylene rope with a group-specific, colour-coded and numbered ellipsoid float (220 mm long x 120 mm maximum diameter) was attached to the top of each pot using a spring loaded stainless steel “shark clip”. A triangular, spring-loaded, stainless steel “bait spike” 150 mm along two sides x 80 mm along the other was cable-tied inside the lower face of the pot.

Control pots, excluding the rope and float, weighed 2.05 kg in air while treatment pots weighed 100 g more. The pot chamber was accessed and bait, crabs and bycatch were inserted and/or removed by undoing a drawstring on the top of the pot.

7.2.2 Study sites and sampling regime

The Adelaide River is a large, perennial, northern-flowing river that originates in Litchfield Park, to the west of the Adelaide River township (13°14'26"S, 131°06'26"E), and discharges into Adam Bay (Figure 7.3). The maximum tidal range at the mouth of the river is approximately 8 m, with the tidal influence extending approximately 68 km inland (as a straight line distance) to Marrakai crossing (12°55'39"S, 131°15'58"E).

The flow rate of the Adelaide River is heavily influenced by the wet/dry monsoonal weather pattern with mean monthly discharge rates ranging from $<1 \text{ m}^3\text{s}^{-1}$ in September-October at the end of the dry season, to $750 \text{ m}^3\text{s}^{-1}$ in January-February at the peak of the wet season (NT Department of Land Resource Management, unpublished data).

The lower reaches of the Adelaide River consist of a wide channel fringed by mud flats that merge into narrow stands of mangrove forest, which in some cases, are backed by extensive salt pans. Several large “arms” branch off the main channel near the mouth of the river and are popular recreational crabbing areas. Limited commercial crabbing also takes place in the Adelaide River.

Experimental crab fishing on the Adelaide River took place in June 2010, September 2010 and May 2011 (Table 7.1). The “Run-off” experiments were planned to take place in March-April, 2011 but were postponed several times due to record wet season rainfall.

Table 7.1. Sampling dates, minimum and maximum predicted daily tidal amplitude (TA) for each trip to the Adelaide River

Season	Start date	End date	Minimum TA (m)	Maximum TA (m)	Trip days
Dry	21 June 2010	29 June 2010	1.5	4.3	9
Build-up	15 September 2010	23 September 2010	0.6	3.6	9
Run-off	9 May 2011	17 May 2011	1.7	4.2	9

The mean size of mud crabs harvested from the Adelaide River is typically greater than that in other areas of the NT (Knuckey, 1999) raising concerns that small crabs may be under-represented in the sample if the use of this pot type was restricted to the Adelaide River only. Therefore, a subset of PE-mesh pots was deployed during wire-mesh potting trials on the Roper River. Details of the sampling timetable for the Roper River are given in Table 6.1.

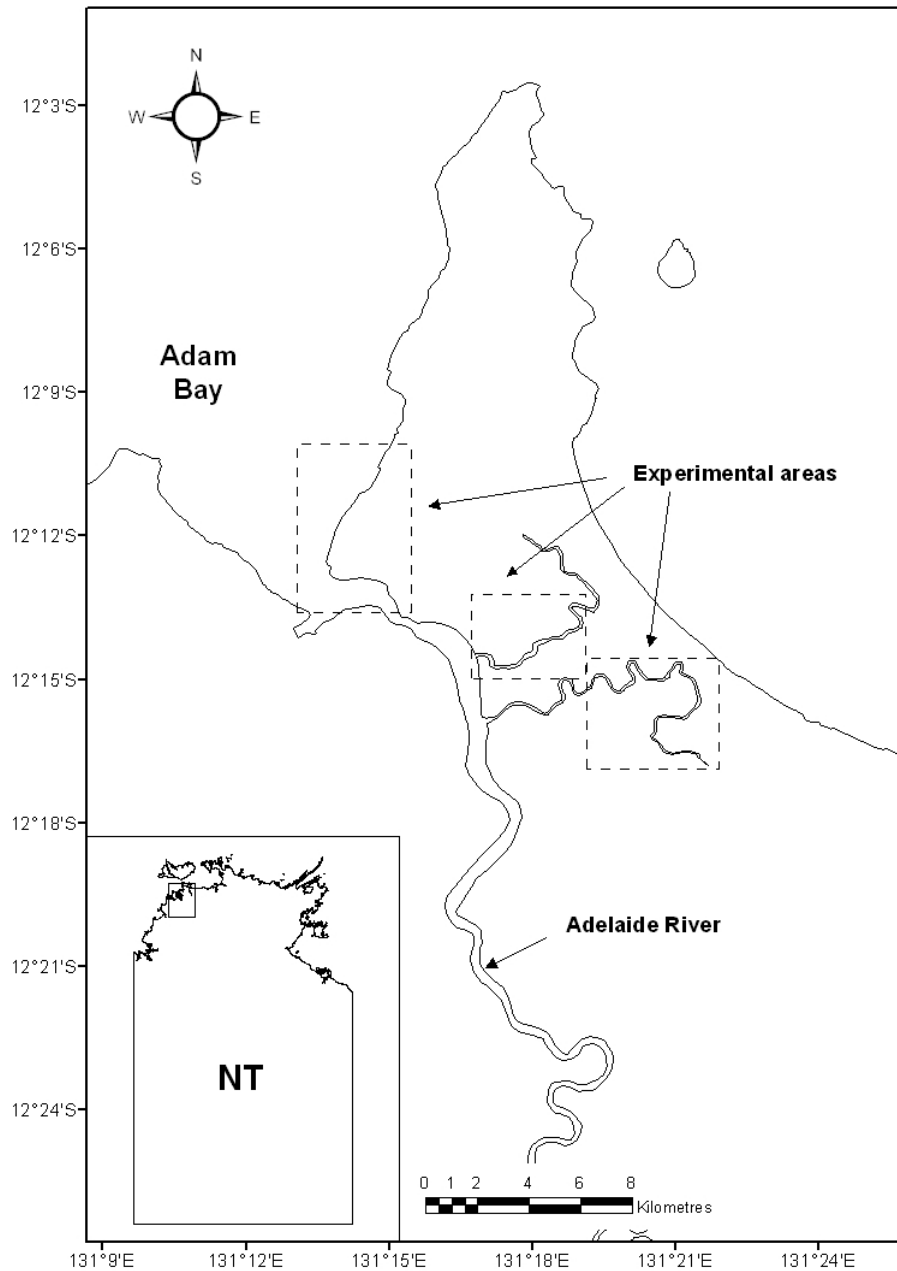

Figure 7.3. Location of the Adelaide River, Northern Territory (NT)

7.2.3 Experimental procedures

The experimental procedures for this study were identical to those given in Section 6.2.3 with the exception of the number of pots per block/group and the fact that the pots were set in two river systems. Trapping trials on the Adelaide River employed 20 blocks of three different pots (one control, one 2x42mm and one 2x50mm pot - giving a total of sixty pots) with ten blocks set from each of two vessels working in different areas of the river. Four blocks of the three different pots (12 pots in total) were also set from a single vessel in the Roper River.

7.2.4 Supplementary data - weight at width relationships for *Scylla serrata* caught by commercial fishers in the Adelaide River

Wet weight (WW; y) data for live, unparasitised, male and female *S. serrata* sampled from the catch of commercial fishers operating in and around the Adelaide River were plotted against CW (x) and the equations for the relationships were used to derive WW estimates from CW measures taken from crabs caught in PE-mesh pots set in the Adelaide River (this study). The same procedure was applied to the CW data for males and females caught in PE-mesh pots set in the Roper River using the weight at width equations described in the previous chapter.

7.2.5 Data analyses

Data from the escape vent experiments using PE-mesh pots was generally analysed in the same manner as that described for wire-mesh pots (Section 6.2.5). Exceptions included a reduced number of experimental treatments (two instead of six) and a greater number of sample sites (two instead of one). SELECT modelling of retention curves for PE-mesh pots set in the Roper River was restricted to pooled-sex data because of the small sample sizes for both males ($n = 32$ to 34) and females ($n = 16$ to 20) in all pot groups.

7.3 RESULTS

7.3.1 General catch statistics

Adelaide River

A total of 855 mud crabs were caught from 2723 pot-lifts on the Adelaide River (Table 7.2). Of these, 12 were identified as the Orange Mud Crab (*S. olivacea*) and the remainder as the Giant Mud Crab (*S. serrata*). Five *S. serrata* caught in this system were infected with the parasite *L. ihlei* and three were found dead inside different pots. Ninety one *S. serrata* and one *S. olivacea* were recaptured, but only during the same period as they were tagged. Within the group of 91 (consisting of 35 females and 56 males), there were 76 single, 10 double, three triple, one quadruple and one quintuple recapture. The recapture rate (including multiple recaptures) differed between seasons, being highest in the dry season (19%) followed by the build-up (13%) and the run-off (11%). The overall recapture rate from this estuary was 14%.

Table 7.2. Fishing effort (pot-lifts), total catch (of *Scylla* spp.), unique catch (excluding *S. olivacea*, recaptures, dead or parasitised animals), effective effort (number of pot-lifts that caught one or more unique crabs) and significance tests for catch by sex (based on unique catch) of *S. serrata* relative to river system and experimental group. Chi-squared (χ^2) values calculated using one degree of freedom. The catch of unique males and females in control and 2x42mm treatment pots set in the Adelaide River were identical.

System	Group	Fishing effort	Total catch	Unique catch	Effective effort	Males	Females	χ^2	p
Adelaide River	Control	904	294	245	212	143	102	6.86	0.009
	2x42mm	908	288	245	213	143	102	6.86	0.009
	2x50mm	911	273	226	193	148	78	21.68	<0.001
	<i>System total</i>	<i>2723</i>	<i>855</i>	<i>716</i>	<i>618</i>	<i>434</i>	<i>282</i>	–	–
Roper River	Control	102	53	50	39	34	16	6.48	0.011
	2x42mm	96	54	52	41	32	20	2.77	0.096
	2x50mm	101	56	50	39	32	18	3.92	0.048
	<i>System total</i>	<i>299</i>	<i>163</i>	<i>152</i>	<i>119</i>	<i>98</i>	<i>54</i>	–	–
Grand total		3022	1018	868	738	532	336	–	–

Effective effort (number of pot-lifts that caught one or more unique crabs) as a proportion of total fishing effort in the Adelaide River was similar among experimental groups, ranging from 21 to 23% (using data from Table 7.2). When the data for this river was analysed by season (using data from Table 7.3), effective effort was low in the dry season (at 17%) and slightly higher in the build-up and run-off (at 25% and 27%, respectively).

The sex ratio of unique *S. serrata* caught in the Adelaide River was significantly biased towards males ($p < 0.05$) across both experimental groups and seasons (Tables 7.2 and 7.3). The proportion of soft (recently-moulted) female crabs in the catch decreased from 30% in the dry season, to 27% in the build-up, to 12% in the run-off. The proportion of soft male crabs was lower and ranged between 5% and 13% of the seasonal catch. The overall incidence of soft crabs captured from the Adelaide River was 16%. No ovigerous females were caught in this system.

Males caught in the Adelaide River ranged in size from 64 to 200 mm CW, whilst females ranged from 90 to 201 mm CW (Figure 7.4). Despite the under-representation of one size category in the male size frequency distribution (165 to 169 mm) a unimodal curve (*cf.* bimodal for females) was the best fit to the data for this sex. The male size distribution was also “flatter” than for females (acknowledging that the data were pooled across season and treatment group). The mean CW of males was significantly greater than that of females (157 mm and 153 mm, respectively), one-way ANOVA, $F_{1,714} = 6.490$, $p = 0.011$.

Table 7.3. Fishing effort (pot-lifts), total catch (of *Scylla* spp.), unique catch (excluding *S. olivacea*, recaptures, dead or parasitised animals), effective effort (number of pot-lifts that caught one or more unique crabs) and significance tests for catch by sex (based on unique catch) of *S. serrata* relative to river system and season. Chi-squared (χ^2) values calculated using one degree of freedom.

System	Season	Fishing effort	Total catch	Unique catch	Effective effort	Males	Females	χ^2	p
Adelaide River	Dry	958	227	178	160	107	71	7.28	0.007
	Build-up	824	276	238	202	95	143	9.68	0.002
	Run-off	941	352	300	256	232	68	89.65	<0.001
	<i>System total</i>	2723	855	716	618	434	282	–	–
Roper River	Dry	103	33	31	21	18	13	0.81	0.368
	Build-up	76	44	43	36	19	24	0.58	0.446
	Run-off	120	86	78	62	61	17	24.82	<0.001
	<i>System total</i>	299	163	152	119	98	54	–	–
Grand total		3022	1018	868	738	532	336	–	–

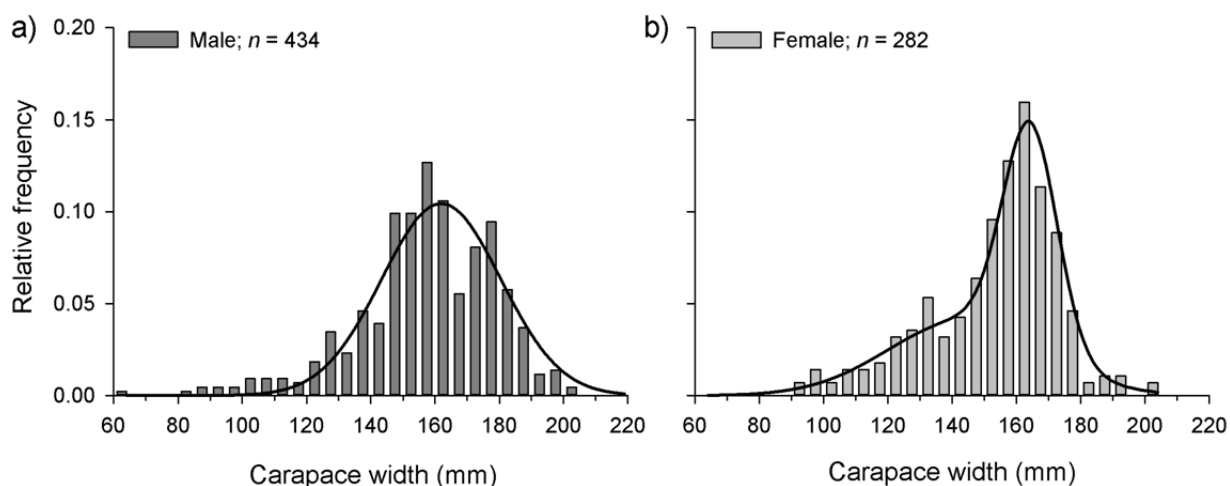

Figure 7.4 Relative size frequency of unique a) male and b) female *Scylla serrata* caught in polyethylene-mesh pots set in the Adelaide River. Upper bin values for each 5-mm size category end with 4 or 9. Parameter values and correlation coefficients for Gaussian curves given in Appendix 3.

Roper River

One hundred and sixty three *S. serrata* were caught from 299 pot-lifts on the Roper River (Table 7.2). All crabs were live when the pots were retrieved and only one male was infected with the parasite *L. ihlei*. Eight individuals (all males) were recaptured, with one double recapture. No recaptures were observed in the dry season; recapture rates in the build-up and run-off were 2% and 9%, respectively. The overall recapture rate from this estuary was 6%.

Effective effort as a proportion of total fishing effort in the Roper River was again consistent among experimental groups, ranging from 38 to 43%. When the data for this river was analysed by season, effective effort was low in the dry season (at 20%) but more than doubled in the build-up and run-off (at 47% and 52%, respectively).

The sex ratio of unique *S. serrata* caught in the Roper River was significantly biased towards males in both the control and 2x50mm groups (Table 7.2). The proportion of males and females in the catch was close to parity in the dry season and the build-up, but was skewed towards males in the run-off (Table 7.3).

No soft crabs were caught in the dry season. Soft male crabs constituted 8% and 6% of the catch in the build-up and run-off, respectively. Corresponding figures for soft female crabs were 5% and 10%. The overall incidence of soft crabs captured from the Roper River was 7%. Ovigerous females were not caught in this system.

Males caught in the Roper River ranged in size from 78 to 181 mm CW whilst females ranged from 87 to 172 mm CW (Figure 7.5). Again, the size distribution for males was “flatter” than that for females (acknowledging that the data was pooled across season and treatment group). There was no significant difference between the mean CW of males and females caught in this system (132 mm and 129 mm, respectively, one-way ANOVA, $F_{1,150} = 0.665$, $p = 0.416$).

The mean CW for males caught in the Roper River was significantly less than for males caught in the Adelaide River (132 mm and 157 mm CW, respectively, one-way ANOVA, $F_{1,530} = 100.14$, $p < 0.001$). The same pattern was observed in the mean CW of females caught in the two systems (129 mm and 153 mm CW, respectively, one-way ANOVA, $F_{1,334} = 60.16$, $p < 0.001$).

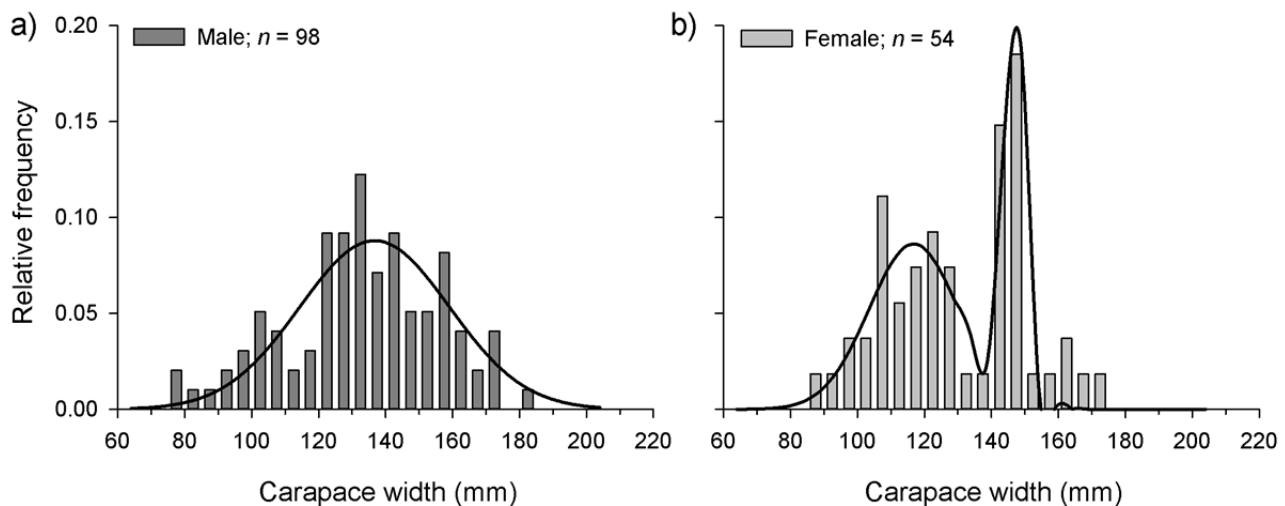

Figure 7.5 Relative size frequency of unique a) male and b) female *Scylla serrata* caught in polyethylene-mesh pots set in the Roper River. Upper bin values for each 5-mm size category end with 4 or 9. Parameter values and correlation coefficients for Gaussian curves are given in Appendix 3.

7.3.2 Supplementary data - weight at width relationships for *Scylla serrata* caught by commercial fishers in the Adelaide River

Carapace widths and WW of male *S. serrata* ($n = 9227$) sampled from the catch of commercial mud-crab fishers operating in and around the Adelaide River ranged from 108 to 207 mm and 195 to 2070 g, respectively. Corresponding figures for females ($n = 5165$) were 104 to 205 mm CW and 175 to 1418 g, respectively.

The relationships between WW and CW for males and females differed and are shown in Figure 7.6. Again, the greater slope of the relationship for males is due to the allometric growth of the chelae which begins when the animal reaches about 130 mm CW (Knuckey, 1999). Likewise, much of the variability in WW for a given CW is due to the inclusion of crabs in different moult stages as well as those missing one or more appendages.

The equations $y = 0.000007x^{3.697}$ and $y = 0.0003x^{2.897}$ were used to estimate WW (x) from CW (y) for each of the 434 unique male and 282 unique female mud crabs caught in the Adelaide River, respectively. These values were then summed for each of the different escape vent treatments and size categories examined.

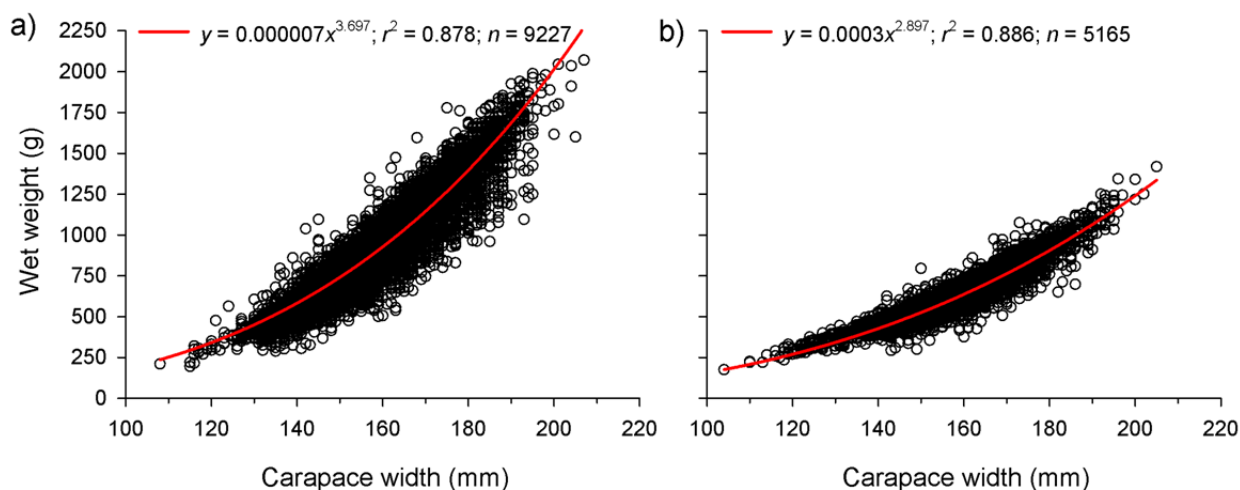

Figure 7.6. Relationships between carapace width and wet weight for a) male and b) female *Scylla serrata* sampled from the catch of commercial fishers operating in the Adelaide River

7.3.3 Catch rates and yield estimates for control and 42 mm vented PE-mesh pots where the lesser (male) minimum legal size is 130 mm carapace width

This subsection presents catch statistics for *S. serrata* caught in PE-mesh pots (with and without two 42-mm escape vents) and separated into one of two size brackets as per the current MLSs for the NT recreational mud crab fishery. Hence, for the purposes of this analysis, the term “under-sized” refers to male crabs <130 mm CW and female crabs <140 mm CW. Likewise, the term “legal-sized” refers to male crabs ≥ 130 mm CW and female crabs ≥ 140 mm CW.

Adelaide River

The catch rate relative to the control (CRC) of under-sized crabs (pooled across sex) in the 2x42mm pots set in the Adelaide River was -23%, whilst that for legal-sized crabs was +6% (Table 7.4). The mean CW of both under-sized males and under-sized females caught in 2x42mm pots was significantly greater than that for crabs of the corresponding sex caught in control pots (one-way ANOVA, male CW, $F_{1,35} = 9.177$, $p = 0.005$; female CW, $F_{1,53} = 6.421$, $p = 0.014$) such that the total estimated WW (ΣWW) of under-sized crabs caught by each pot type was almost identical, despite the reduced catch of under-sized crabs in treatment pots.

The CRC values for under-sized males and females caught in 2x42mm pots were very similar (-24% and -23%, respectively) as were those of legal-sized animals caught in this pot type (+4% for males and +9% for females). The mean CW of both legal-sized males and legal-sized females caught in 2x42mm pots was not significantly different from that for crabs of the corresponding sex caught in control pots. One way ANOVA, male CW $F_{1,247} = 0.007$, $p = 0.931$; female CW, $F_{1,147} = 0.882$, $p = 0.349$.

Table 7.4. Catch, mean size, total estimated weight and catch rate statistics for unique male (♂) and female (♀) *Scylla serrata* in different size categories (reflecting current minimum legal sizes for the NT recreational fishery) caught in vented and unvented (control) polyethylene-mesh pots set in the Adelaide River. See Table 7.2 for the number of pot-lifts per group. Threshold significance level = 0.05.

Sex/size category (mm) and pot group	No. crabs ^a	Mean carapace width (mm) ^b	s.e.	Σ wet weight (kg)	Mean CPUE ^c	s.e.	Catch relative to control ^d	U-statistic	p-value
♂ <130; ♀ <140									
Control	52	113.4	2.3	14.82	0.058	0.008	-	-	-
2x42mm	40	124.2	1.5	14.63	0.044	0.007	-23%	404896	0.188
♂ ≥130; ♀ ≥140									
Control	193	162.1	1.0	185.94	0.213	0.016	-	-	-
2x42mm	205	161.3	1.0	194.59	0.226	0.016	6%	405722	0.542
♂ <130									
Control	21	105.5	3.4	4.87	0.023	0.005	-	-	-
2x42mm	16	119.4	2.7	5.53	0.018	0.004	-24%	408560	0.491
♂ ≥130									
Control	122	161.4	1.5	130.53	0.135	0.013	-	-	-
2x42mm	127	161.2	1.5	135.37	0.140	0.012	4%	406785	0.573
♀ <140									
Control	31	118.8	2.7	9.94	0.034	0.006	-	-	-
2x42mm	24	127.3	1.5	9.10	0.026	0.006	-23%	406754	0.264
♀ ≥140									
Control	71	163.2	1.2	55.41	0.079	0.010	-	-	-
2x42mm	78	161.6	1.3	59.22	0.086	0.010	9%	406987	0.503

^a values in bold referred to in Table 9.2

^c Catch per unit effort (CPUE) as crabs per pot-lift

^b values in bold referred to in Table 9.1

^d values for under-sized and legal-sized crabs referred to in Tables 9.3 and 9.5 respectively

Catch rates (pooled across season) for each sex and size category in the 2x42mm pots set in the Adelaide River were not significantly different from those for control pots set in the same system (see *p*-values in Table 7.4). However, when the data was analysed by season, the catch rate of under-sized males in 2x42mm pots set during the run-off was significantly less than that of under-sized males in control pots set during the same period ($U = 47054$, $p = 0.039$). No other significant differences were found.

Using the total estimated WW of unique, legal-sized crabs caught in unvented PE-mesh pots set in the Adelaide River (185.9 kg; Table 7.4) and the number of corresponding pot-lifts (904; Table 7.2), the CPUE (by weight) of this group of crabs in the aforementioned pot type set in the Adelaide River was 0.21 kg/pot-lift.

Roper River

The CRC of under-sized crabs (pooled across sex) in the 2x42mm pots set in the Roper River was +2%, whilst that for legal-sized crabs was +18% (Table 7.5). The CRC values for under-sized male and female crabs were very different (-9% and +18%, respectively), as were those for legal-sized male and female crabs (+6% and +52%, respectively). Confidence in these values is modest at best because of the small sample sizes on which they are based.

Significance testing of mean CW for females (within each size category) caught in control and experimental pots set in the Roper River was not attempted because of the very small number of females (in either size category) captured ($n \leq 10$). The mean CW of both under-sized males and legal-sized males caught in 2x42mm pots was not significantly different to that for males in corresponding size categories caught in

control pots (one-way ANOVA, under-sized males $F_{1,24} = 1.009$, $p = 0.325$; legal-sized males, $F_{1,39} = 0.129$, $p = 0.722$).

Conclusions regarding differences (or otherwise) in the total estimated WW (ΣWW) for each sex and size category relative to gear type cannot be made with any confidence because of the small sample sizes and lack of variation in mean size for crabs caught in the Roper River.

Catch rates (pooled across season) for each sex and size category in the 2x42mm pots set in the Roper River were not significantly different from those for control pots set in the same system (see p -values in Table 7.5).

Using the total estimated WW of unique, legal-sized crabs caught in unvented PE-mesh pots set in the Roper River (18.3 kg; Table 7.5) and the number of corresponding pot-lifts (102; Table 7.2), the CPUE of this group of crabs in the aforementioned pot type set in the Roper River was 0.18 kg/pot-lift. Statistical tests on seasonal catch rates in the Roper River were not attempted due to the small sample size and (in some cases) lack of crabs above the MLS.

Table 7.5. Catch, mean size, total estimated weight and catch rate statistics for unique male (σ) and female (ϕ) *Scylla serrata* in different size categories (reflecting current minimum legal sizes for the NT recreational fishery) caught in vented and unvented (control) polyethylene-mesh pots set in the Roper River. See Table 7.2 for the number of pot-lifts per group. Threshold significance level = 0.05.

Sex/size category (mm) and pot group	No. crabs	Mean carapace width (mm)	s.e.	Σ wet weight (kg)	Mean CPUE ^a	s.e.	Catch relative to control	U-statistic	p-value
$\sigma < 130$; $\phi < 140$									
Control	23	113.7	2.8	6.33	0.225	0.052	-	-	-
2x42 mm	22	117.0	2.3	6.57	0.229	0.056	2%	4895	0.999
$\sigma \geq 130$; $\phi \geq 140$									
Control	27	147.6	2.6	18.34	0.265	0.050	-	-	-
2x42 mm	30	146.6	2.1	19.39	0.313	0.050	18%	4601	0.341
$\sigma < 130$									
Control	14	111.1	4.2	3.66	0.137	0.042	-	-	-
2x42 mm	12	116.8	3.6	3.62	0.125	0.037	-9%	4874	0.922
$\sigma \geq 130$									
Control	20	147.8	3.4	14.31	0.196	0.044	-	-	-
2x42 mm	20	146.2	2.8	13.54	0.208	0.044	6%	4801	0.729
$\phi < 140$									
Control	9	117.6	2.6	2.68	0.088	0.031	-	-	-
2x42 mm	10	117.1	2.7	2.95	0.104	0.043	18%	4874	0.907
$\phi \geq 140$									
Control	7	147.1	2.1	4.03	0.069	0.029	-	-	-
2x42 mm	10	147.5	3.0	5.85	0.104	0.031	52%	4679	0.255

^a Catch per unit effort (CPUE) as crabs per pot-lift

7.3.4 Catch rates and yield estimates for control and 50 mm vented PE-mesh pots where the minimum legal size is 150 mm carapace width

This subsection presents catch statistics for *S. serrata* caught in PE-mesh pots (with and without two 50 mm escape vents) and separated into one of two size brackets using an MLS of 150 mm CW (as per the male MLS for the Qld mud crab fishery but ignoring the male only harvest policy). Hence, for the purposes of this analysis, the terms “under-sized” and “legal-sized” refer to crabs <150 mm CW and ≥ 150 mm CW, respectively.

Adelaide River

The CRC for under-sized crabs (pooled across sex) in 2x50mm pots set in the Adelaide River was -40%, whilst that for legal-sized crabs was +9% (Table 7.6). The total estimated WW of under-sized crabs caught in the 2x50mm pots was almost 10 kg (or 25%) less than that in the control pots.

The CRC values for under-sized males and under-sized females caught in 2x50mm pots were similar (-42% and -37%, respectively) as were those for legal-sized crabs (+6% for males and +9% for females). The mean CW of both under-sized males and under-sized females caught in 2x50mm pots was significantly greater than that for crabs of the corresponding sex and size category caught in control pots (one-way ANOVA, male CW, $F_{1,82} = 5.353$, $p = 0.023$; female CW, $F_{1,57} = 8.421$, $p = 0.005$).

The mean CW of both legal-sized males and legal-sized females caught in 2x50mm pots was not significantly different from that for crabs of the corresponding sex and size category caught in control pots (one-way ANOVA, male CW, $F_{1,205} = 1.570$, $p = 0.212$; female CW, $F_{1,119} = 0.441$, $p = 0.508$).

Catch rates (pooled across season) of i) all under-sized crabs and ii) under-sized males were significantly lower (at the 5% level) in the 2x50mm pots set in the Adelaide River than those for control pots set in the same system (see p -values in Table 7.6). It should also be noted that the reduction in catch rate of under-sized female crabs in vented pots was significant at the 10% level.

A number of significant differences in catch rates (at 10% and 5% levels) of crabs between control and 2x50mm pots set in the Adelaide River were detected when the data was analysed on a seasonal basis (see Table 7.7). The decrease in the catch rate of under-sized males in the dry-season and run-off drove the overall decline in the catch of all under-sized crabs during these seasons.

Table 7.6. Catch, mean size, total estimated weight and catch rate statistics for unique male (♂) and female (♀) *Scylla serrata* in different size categories (reflecting current male and hypothetical female minimum legal sizes for the Qld fishery) caught in vented and unvented (control) polyethylene-mesh pots set in the Adelaide River. See Table 7.2 for the number of pot-lifts per group. Threshold significance level = 0.05.

Sex/size category (mm) and pot group	No. crabs	Mean carapace width (mm)	s.e.	Σ wet weight (kg)	Mean CPUE ^a	s.e.	Catch relative to control ^b	U-statistic	p-value
♂ and ♀ <150									
Control	89	125.4	2.1	37.91	0.098	0.011	-	-	-
2x50mm	54	136.2	1.9	28.53	0.059	0.008	-40%	396968	0.004
♂ and ♀ ≥150									
Control	156	166.8	0.9	162.85	0.173	0.014	-	-	-
2x50mm	172	165.3	0.8	179.00	0.189	0.015	9%	408403	0.634
♂ <150									
Control	53	127.4	2.9	25.20	0.059	0.008	-	-	-
2x50mm	31	137.1	2.4	17.97	0.034	0.006	-42%	402977	0.026
♂ ≥150									
Control	90	168.4	1.4	110.21	0.100	0.011	-	-	-
2x50mm	117	166.2	1.1	136.01	0.128	0.013	29%	402388	0.111
♀ <150									
Control	36	122.5	2.8	12.71	0.040	0.007	-	-	-
2x50mm	23	135.0	3.1	10.56	0.025	0.005	-37%	405770	0.080
♀ ≥150									
Control	66	164.6	1.2	52.65	0.073	0.009	-	-	-
2x50mm	55	163.4	1.3	42.99	0.060	0.008	-17%	407461	0.352

^a Catch per unit effort (CPUE) as crabs per pot-lift

^b values for under-sized and legal-sized crabs referred to in Tables 9.3 and 9.5 respectively

Table 7.7. Significant differences (at 10% and 5% levels) in catch rates between control and 2x50mm pots (set in the Adelaide River) and the direction of change relative to sex/size category and season

Sex/size category (mm)	Season	Difference to control	U-statistic	p-value
♂ <150	Dry	decrease	49772	0.088
	Run-off	decrease	46966	0.062
♂ ≥150	Build-up	increase	35860	0.008
♀ <150	Run-off	increase	47678	0.058
♀ ≥150	Dry	decrease	49612	0.098
♂ and ♀ <150	Dry	decrease	49143	0.059
	Run-off	decrease	45830	0.009

Roper River

The CRC of under-sized crabs (pooled across sex) caught in 2x50mm pots set in the Roper River was -4%, whilst that for legal-sized crabs was +21% (Table 7.8). The CRC value for under-sized male crabs was negative (-7%) whilst that for legal-sized males was just above parity (1%). The CRC value for under-sized females was also just above parity (1%) but that for legal-sized females was much greater (+203%). The latter hyper-inflated value is a result of the very small combined sample size ($n = 4$) for legal-sized females caught in the control and experimental pots.

The mean CW of both under-sized males and under-sized females caught in 2x50mm pots was not significantly different from that for crabs of the corresponding sex caught in control pots (one-way ANOVA, male CW $F_{1,46} = 0.680$, $p = 0.414$; female CW, $F_{1,28} = 2.694$, $p = 0.112$). Significance testing of the mean CW for legal-sized crabs (of both sexes) caught in control and 2x50mm pots was not attempted because of the very small number of legal-sized crabs ($n \leq 10$) caught by either pot type.

Again, conclusions regarding differences (or otherwise) in the total estimated WW (ΣWW) for each sex and size category relative to gear type cannot be made with any confidence because of the small sample sizes and lack of variation in mean size for crabs caught in the Roper River.

Catch rates (pooled across season) for each sex and size category in the 2x50mm pots set in the Roper River were not significantly different from those for control pots set in the same system (see U -statistics and p -values in Table 7.8). Statistical tests on seasonal catch rates in the Roper River were not conducted due to the small sample size and (in some cases) lack of crabs above the MLS.

Table 7.8. Catch, mean size, total estimated weight and catch rate statistics for unique male (♂) and female (♀) *Scylla serrata* in different size categories (reflecting current male and hypothetical female minimum legal sizes for the Qld fishery) caught in vented and unvented (control) polyethylene-mesh pots set in the Roper River. See Table 7.2 for the number of pot-lifts per group. Threshold significance level = 0.05.

Sex/size category (mm) and pot group	No. crabs	Mean carapace width (mm)	s.e.	Σ wet weight (kg)	Mean CPUE ^a	s.e.	Catch relative to control	U -statistic	p -value
♂ and ♀ <150									
Control	40	124.6	2.7	15.26	0.392	0.063	-	-	-
2x50mm	38	117.5	3.3	12.49	0.376	0.064	-4%	5061	0.791
♂ and ♀ ≥150									
Control	10	161.6	2.9	9.41	0.098	0.030	-	-	-
2x50mm	12	159.8	2.2	10.40	0.119	0.032	21%	5044	0.636
♂ <150									
Control	25	122.1	3.6	9.26	0.245	0.051	-	-	-
2x50mm	23	117.7	4.1	7.68	0.228	0.044	-7%	5123	0.926
♂ ≥150									
Control	9	162.0	3.2	8.71	0.088	0.028	-	-	-
2x50mm	9	158.8	2.7	8.06	0.089	0.028	1%	5147	0.985
♀ <150									
Control	15	128.7	4.0	6.00	0.147	0.043	-	-	-
2x50mm	15	117.3	5.7	4.81	0.149	0.041	1%	5102	0.837
♀ ≥150									
Control	1	158.0	0.0	0.71	0.010	0.010	-	-	-
2x50mm	3	163.0	3.0	2.34	0.030	0.017	203%	5049	0.311

^a Catch per unit effort (CPUE) as crabs per pot-lift

7.3.5 SELECT modelling of data from PE-mesh pots

Adelaide River

Based on the ranked values of AIC, the Richards' function with unequal fishing efficiency (estimated p) was (with one exception) the most parsimonious fit to the data for both 2x42mm and 2x50mm vented pots set in the Adelaide River (Tables 7.9 and 7.10). In the case of males caught in 2x42mm pots, Richards' function with unequal fishing was the second best fit after the logistic function with equal fishing efficiency. For the sake of consistency only the Richards' functions are plotted in Figure 7.7.

Table 7.9. Results of SELECT modelling of 2x42mm vented polyethylene-mesh pots set in the Adelaide River. The Akaike's Information Criterion (AIC) value was used to rank the different models in order of the most parsimonious fit.

Sex	Curve	p eq1	Parameter estimates				L_{50}	SR	AIC	Rank
			p	a	b	δ				
Pooled	Logistic	0.50 ¹	-	-16.8	1.51	1	111.5	14.6	90.07	3
	Logistic	-	0.53	-16.4	1.46	1	112.9	15.1	91.09	4
	Richards	0.50 ¹	-	-927	74.7	91.9	115.5	13.5	89.49	2
	Richards	-	0.52	-929	74.8	87.1	116.1	12.8	88.55	1
♂	Logistic	0.52 ²	-	-13.9	1.29	1	108.4	17.1	77.43	1
	Logistic	-	0.52	-13.9	1.28	1	108.8	17.2	79.10	4
	Richards	0.52 ²	-	-927	74.8	118.2	113.1	17.4	78.50	3
	Richards	-	0.52	-928	74.8	117.0	113.2	17.2	78.48	2
♀	Logistic	0.51 ³	-	-23.6	2.02	1	116.4	10.8	72.15	2
	Logistic	-	0.53	-23.4	1.99	1	117.4	11.0	73.70	4
	Richards	0.51 ³	-	-926	74.7	55.7	118.8	8.2	72.51	3
	Richards	-	0.53	-927	74.7	53.1	119.0	7.9	72.12	1

¹ $p = 213/425$; ² $p = 133/258$; ³ $p = 95/187$

Table 7.10. Results of SELECT modelling of 2x50mm vented polyethylene-mesh pots set in the Adelaide River. The Akaike's Information Criterion (AIC) value was used to rank the different models in order of the most parsimonious fit.

Sex	Curve	p eq1	Parameter estimates				L_{50}	SR	AIC	Rank
			p	a	b	δ				
Pooled	Logistic	0.48 ¹	-	-11.4	0.97	1	118.7	22.8	92.88	4
	Logistic	-	0.53	-9.9	0.78	1	126.1	28.1	91.14	2
	Richards	0.48 ¹	-	-1192	82.8	212.3	126.3	28.2	92.46	3
	Richards	-	0.52	-1185	81.6	188.1	129.4	25.3	89.28	1
♂	Logistic	0.51 ²	-	-11.9	0.97	1	122.4	22.6	81.53	2
	Logistic	-	0.57	-10.2	0.79	1	129.5	27.8	81.58	3
	Richards	0.51 ²	-	-1151	75.2	234.4	131.5	34.2	82.87	4
	Richards	-	0.56	-1145	74.1	200.9	135.7	29.8	80.73	1
♀	Logistic	0.44 ³	-	-11.0	0.96	1	114.6	22.9	67.87	2
	Logistic	-	0.48	-9.8	0.82	1	119.7	26.9	69.16	4
	Richards	0.44 ³	-	-1192	82.7	249.1	123.2	33.1	68.78	3
	Richards	-	0.48	-1191	82.6	210.5	126.5	28.0	67.63	1

¹ $p = 193/405$; ² $p = 131/256$; ³ $p = 72/164$

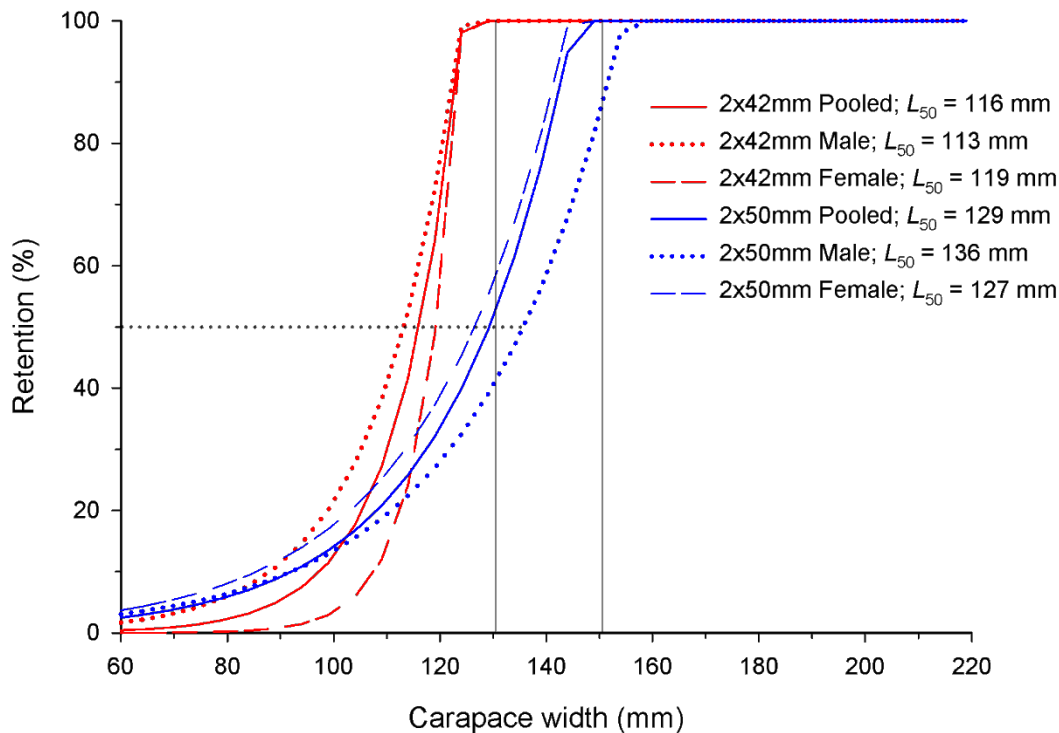

Figure 7.7. Pooled and sex-specific selectivity curves (Richards' functions with estimated p) for *Scylla serrata* caught in 2x42mm (red lines) and 2x50mm (blue lines) vented polyethylene-mesh pots set in the Adelaide River. The horizontal dotted line intersects the length at 50% retention (L_{50}) for each curve. The left and right vertical lines represent the minimum legal sizes for males harvested by the NT recreational fishery and the Qld mud crab fishery, respectively.

The size at which 50% of *S. serrata* (pooled across sex) were retained in 2x42mm pots (L_{50}) was 116 mm (Table 7.9 and Figure 7.7). When modelled separately, the L_{50} estimates for females and males were 3 mm above and below the value for the pooled data, respectively. Corresponding L_{50} estimates for crabs (of either sex or pooled) caught in 2x50mm pots were between 8 mm and 23 mm greater than those for pots fitted with the smaller escape vents (Table 7.10 and Figure 7.7). The difference in L_{50} estimates between males and females caught in 2x50mm pots was reversed, with the estimate for males being greater (136 mm) and females being lesser (127 mm).

Roper River

SELECT modelling of sex-specific data from PE-mesh pots set in the Roper River was not attempted owing to the very small sample sizes for both sexes. Even when the data from this river were pooled across sex, some of the model outputs were questionable. Although the logistic curves with equal fishing efficiency provided the most parsimonious fit to the data (Table 7.11), the selection range (SR) for these curves were very narrow (and in one case unrealistically so). Outputs for the 2x50mm pots were also unusual in that all L_{50} estimates were less than those obtained for the 2x42mm pots.

Acknowledging that the small sample size from the Roper River hindered the SELECT modelling approach and that some of the model outputs may be compromised, it is important to contrast the logistic selectivity curves (and associated L_{50} estimates) from this river with those obtained from the Adelaide River given the large difference in the mean CW of crabs caught in the two systems. Selectivity curves for crabs caught in vented pots set in the Roper River were to the left of those for crabs caught in corresponding pots set in the Adelaide River (Figure 7.8), with the difference in L_{50} values between rivers ranging from 25 mm (for 2x42mm pots) to 46 mm (for 2x50mm pots).

Table 7.11. Results of SELECT modelling of 2x42mm and 2x50mm vented polyethylene-mesh pots set in the Roper River. The Akaike's Information Criterion (AIC) value was used to rank the different models in order of the most parsimonious fit.

Treatment	Curve	ρ eq1	Parameter estimates				L_{50}	SR	AIC	Rank
			ρ	a	b	δ				
2x42mm	Logistic	0.51 ¹	-	-464	53.6	1	86.6	0.4	45.56	1
	Logistic	-	0.52	-464	53.6	1	86.6	0.4	47.54	2
	Richards	0.51 ¹	-	-640	61.6	93.0	93.3	16.6	49.32	=3
	Richards	-	0.53	-772	67.6	170.5	96.6	27.7	49.32	=3
2x50mm	Logistic	0.50 ²	-	-22.8	3.12	1	72.9	7.0	62.19	1
	Logistic	-	0.50	-22.8	3.12	1	73.0	7.0	64.19	3
	Richards	0.50 ²	-	-486	54.6	123.8	73.3	24.9	64.09	=2
	Richards	-	0.50	-486	54.6	120.4	73.7	24.2	64.09	=2

¹ $p = 41/80$; ² $p = 39/78$

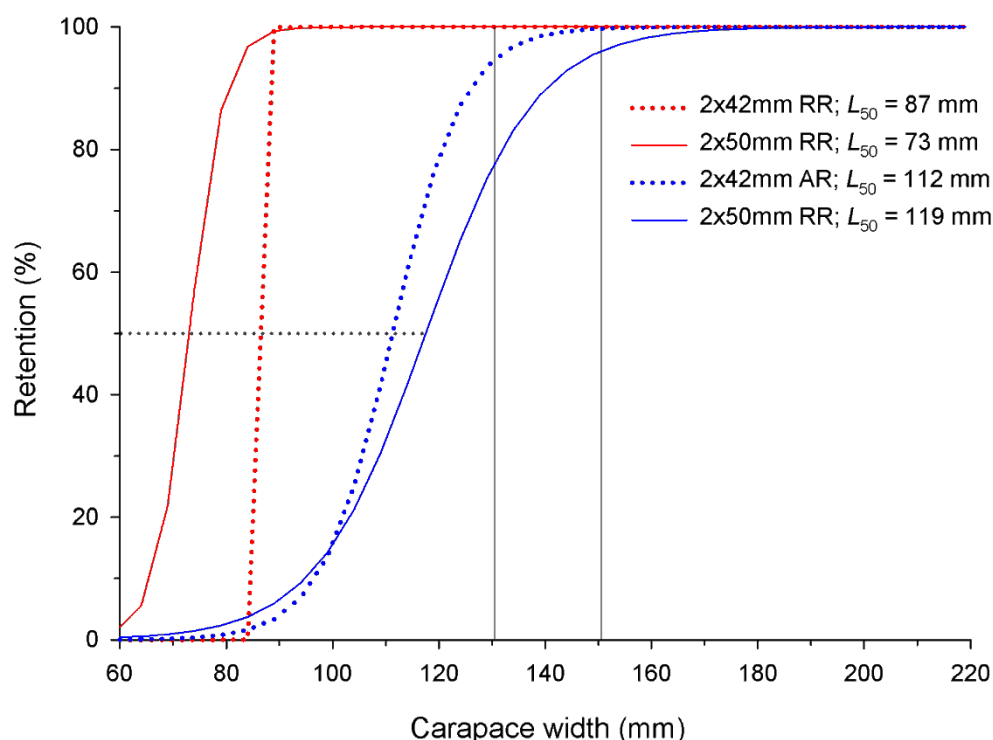

Figure 7.8. Selectivity curves (logistic functions with equal ρ - pooled across sex) for *Scylla serrata* caught in 2x42mm and 2x50mm vented polyethylene-mesh pots set in Roper River (RR; red lines) and Adelaide River (AR; blue lines). The horizontal dotted line intersects the length at 50% retention (L_{50}) for each curve. The left and right vertical lines represent the minimum legal sizes for males harvested by the NT recreational fishery and the Qld mud crab fishery, respectively.

7.3.6 Gear and bycatch summary

Overall bait retention rates (pooled across rivers and seasons) for the control, 2x42mm and 2x50mm treatments were 78%, 76% and 73%, respectively. Corresponding figures for the incidence of pot damage were 3%, 3% and 5%.

A total of 377 individual fishes belonging to at least 14 species/groups were recorded as bycatch from 2713 hauls of PE-mesh pots in the Adelaide and Roper rivers (Table 7.12). Ninety two percent (348) of these

fishes were caught in the Adelaide River. The incidence of teleost bycatch in PE-mesh pots (pooled across groups) set in these rivers was 12.78 and 8.36 fish/100 pot-lifts, respectively.

The number of fishes caught in control pots was 2.6 and 4.1 times greater than that in the 2x42mm and 2x50mm treatments, respectively. Darwin Toadfish (*Marilyna darwinii*) were the most numerous piscine bycatch (190 individuals pooled across groups) followed by catfish (*Arius* spp.) 138 individuals and croakers (*Protonibea* and *Johnius* spp.) 11 individuals. Bycatch totals for all other fish species were less than 10 individuals.

Blue Swimmer Crabs (*Portunus armatus*) were the most common crustacean bycatch in PE-mesh pots (294 individuals) followed by hermit crabs (*Paguristes* spp.) 199 individuals, mangrove crabs (*Myomenippe fornassinii*) four individuals and Cherabin (*Macrobrachium spinipes*) two individuals. Approximately 1000 unidentified jellyfish were also caught in this gear type.

7.4 DISCUSSION

Even when applying a lesser MLS (≥ 130 mm CW for males and ≥ 140 mm CW, as per the NT recreational MLS) our catch rate (by weight) of *S. serrata* in unvented PE-mesh pots set in the Adelaide River was only 0.21 kg/pot-lift, around half of the concurrent commercial catch rate (using wire-mesh pots) in this area (unpublished data). The corresponding value for PE-mesh pots set in the Roper River was 0.18 kg/pot-lift, around one third of the concurrent commercial catch rate in that area (unpublished data). Possible reasons for these differences are discussed in Chapter 6.

The overall recapture rate of *S. serrata* (including multiple recaptures) in PE-mesh pots set in the Adelaide River (14%) was more than double than for the same pot type set in the Roper (6%). The latter recapture rate is similar to the corresponding value for wire-mesh pots set in the same estuary (4%, Chapter 6). Recapture rates observed during our work approximate the range of values recorded for *S. serrata* in the NT (22%, Knuckey, 1999), Qld (19%, Hyland et al., 1984) and NSW (9%, Butcher et al., 2012).

Seasonal patterns in sex ratio and the incidence of soft crabs (as well as a lack of ovigerous females) caught in PE-mesh pots set in the Adelaide and Roper rivers were again consistent with previous observations for these areas by Knuckey (1999) and Ward et al. (2008).

The proportion of small crabs (those < 120 mm CW) caught in unvented (25 mm x 25 mm) PE-mesh pots set in the Adelaide River was 13% (data not shown), similar to those figures obtained from 75 x 50 mm wire mesh pots set in the same river in 2002 (18%) and 2003 (15%) by Hay et al., (2005). Our results from the Adelaide River are also similar to those for small crabs caught in collapsible PE-mesh pots set throughout Qld during the Long Term Monitoring Program (19%, see Chapter 8).

Bait retention in the different groups of PE-mesh pots ranged from 73 to 78%, which was around 15 to 20% less than the figures for wire-mesh pots (Chapter 6). The incidence of damage to PE-mesh pots (3 to 5%) was around double that for wire-mesh pots. The reduction in bait retention and increase in pot damage (relative to wire-mesh pots) was primarily due to small (1.5 to 2.0 metre) saltwater crocodiles in the Adelaide River stealing bait and damaging pots whilst doing so.

The incidence of piscine bycatch in 25 mm x 25 mm PE-mesh pots set in the Adelaide River (12.78 fish/100 pot-lifts) was greater than that of identical pots set in the Roper River (8.36 fish/100 pot-lifts). These rates approximate those for fishes and elasmobranchs caught in similar (generally 50 mm x 50 mm) PE-mesh pots set in Qld. Using data presented in Hay et al. (2005) we calculated a bycatch rate of 16.22 fish/100 pot-lifts across five sampling trips in the eastern GOC. Analysis of data collected in 2002 and presented by Jebreen et al. (2008) yielded a bycatch rate of 13.32 fish/100 pot-lifts.

Table 7.12. Mean incidence of bycatch species in polyethylene-mesh pots (pooled across rivers) with and without escape vents (EV) of different sizes. Figures below treatment names refer to the number of pot-lifts for that treatment where bycatch records were taken. Dash indicates species not recorded. An asterisk (*) indicates only one observation per treatment.

Phylum	Species	Control 901	2x42mm EV 902	2x50mm EV 910
Vertebrata	Archerfish* <i>Toxotes</i> spp.	-	-	<1%
	Barramundi* <i>Lates calcarifer</i>	-	<1%	-
	Barred Javelin <i>Pomadasys kaakan</i>	<1%	<1%	<1%
	Bream <i>Acanthopagrus</i> spp.	<1%	<1%	<1%
	Catfish <i>Arius</i> spp.	10%	3%	2%
	Croakers <i>Protonibea</i> and <i>Johnius</i> spp.	<1%	<1%	<1%
	Darwin Toadfish <i>Marilyna darwinii</i>	14%	3%	4%
	Estuarine Stonefish <i>Synanceia horrida</i>	<1%	<1%	-
	Estuary Cod <i>Epinephelus coioides</i>	<1%	<1%	<1%
	King Threadfin* <i>Polydactylus macrochir</i>	-	<1%	<1%
	Mullet* <i>Liza</i> spp.	-	<1%	-
	Northern Whiting* <i>Sillago sihama</i>	-	-	<1%
	Remora* <i>Remora remora</i>	-	<1%	-
Yellowstriped Scad <i>Selaroides leptolepis</i>	<1%	-	-	
Crustacea	Blue Swimmer Crab <i>Portunus armatus</i>	24%	4%	4%
	Cherabin <i>Macrobrachium spinipes</i>	<1%	<1%	-
	Hermit crab <i>Paguristes</i> spp.	12%	6%	4%
	Mangrove crab <i>Myomenippe fornassinii</i>	<1%	<1%	<1%
Cnidaria	Jellyfish Class Scyphozoa	36%	31%	42%

Notably, the teleost bycatch rate in circular PE-mesh pots set in northern NSW can be very high, with an estimate derived from the work of Butcher et al. (2012) being 159.44 fish/100 pot-lifts. In that case, 97% of the bycatch was the Yellowfin Bream (*Acanthopagrus australis*). If this species is excluded from the analysis, the bycatch rate becomes 16.67 fish/100 pot-lifts, similar to the estimates given above. Clearly, factors such as regional differences in the abundance of bycatch species and the soak time of the pots will have a bearing on such estimates.

Both escape vent treatments produced a noticeable reduction in the CPUE of under-sized crabs when used in the Adelaide River (CRC values of around -20% and -40% for the 2x42mm and 2x50mm EV treatments, respectively – noting that the different treatments were designed to suit different MLSs). There were also small gains in the CPUE of legal-sized crabs (6 to 9%) when these treatments were used in the Adelaide River.

The efficacy of the two escape vent treatments in the Roper River was quite different to that for the Adelaide River. There was little or no decrease in the retention of under-sized crabs for either treatment in the former river system (CRC values of 2% and -4% for under-sized crabs caught in 2x42mm and 2x50mm treatments, respectively). There were however, modest (18% to 21%) increases in the CPUE of legal-sized crabs for both pot treatments when used in the Roper River.

Acknowledging the large difference in sampling effort between the Adelaide and Roper rivers, and its potential impact on the validity of the inferences drawn here, it would appear that differences in the size structure of mud crab populations in different areas has a bearing on the efficacy of escape vents. One may reasonably assume that the use of escape vents in areas where the mean size of crabs is relatively small (resulting in a high release fraction) would be more beneficial than where it is relatively large (resulting in a low release fraction). However, our data suggests otherwise, in fact the complete opposite.

For example, the magnitude of the change in CPUE of under-sized crabs in vented PE-mesh pots (relative to unvented control pots) set in the Adelaide River, where the mean size was comparatively large (155 mm CW), was greater than that for under-sized crabs caught in identical pots set in the Roper River, where the mean size of crabs was considerably smaller (131 mm CW). Based on this observation, we suggest that the probability of an under-sized crab using an escape vent will increase proportionally to the difference between its CW and that of other (larger) crabs that enter the pot. Put simply, a small crab will be less stressed in a pot with other small crabs and more stressed (and more likely to use the escape vent) if a much larger crab enters.

Increased catch rates of crabs in vented, compared with unvented pots, have been observed on several occasions (Guillory and Hein, 1998; Guillory et al., 2004; Tallack, 2007; Boutson et al., 2009) but this phenomenon is by no means universal. A common explanation in these cases is that small crabs that escape through vents free up space inside the pot for other, potentially larger crabs to enter and be retained.

Given the above, one could postulate that any increase in catch rate of legal-sized crabs should be proportional to the reduction in “trap saturation” arising from the use of escape vents. However, our results are not consistent with this line of argument; there was a minor (6 to 9%) increase in the CPUE of legal-sized crabs in vented pots set in the Adelaide River (where the reduction in CPUE of under-sized crabs was greatest) and larger increase (18 to 21%) in the CPUE of legal-sized crabs in vented pots set in the Roper River (where the reduction in CPUE of under-sized crabs was much lower). We do not have an explanation for this observation.

SELECT modelling of the catch data for PE-mesh pots set in the Adelaide River indicated that Richards' curve with unequal fishing efficiency (estimated p) was the best fit to the data in most cases (Tables 7.9 and 7.10). The estimate of L_{50} (using pooled sex data) for 2x42mm treatment pots set in the Adelaide River was 116 mm CW, whilst that for 2x50mm pots set in the same system was greater, at 129 mm CW (Figure 7.7).

Based on these values, each 1 mm increase in the height of the escape vent resulted in a 1.6 mm increase in the value of L_{50} (as CW).

Model outputs using sex-specific data were close to those for the pooled sex data set, although there were noticeable differences in L_{50} estimates for males and females (Figure 7.7). This point is of particular relevance to the NT mud crab fishery because of the differences in the MLSs applied to males and females.

Similar to the situation described in Chapter 6 for wire-mesh pots, the modest sample size of crabs caught in PE-mesh pots set in the Roper River hindered SELECT modelling of data for this pot type and location (Figure 7.8). That said, the L_{50} estimates for vented pots set in the Roper River were much less than those for corresponding pots set in the Adelaide River. Again, this observation is likely due to the large difference in the size structure of the crab populations inhabiting these rivers.

The benefits of fitting escape vents to PE-mesh pots were clearly evident from comparative fishing trials in the Adelaide River but less so for trials in the Roper River. The size structure of the crab population (which can vary spatially and temporally) appears to have a strong bearing on the efficacy of escape vents. Hence, the catch rates of both under-sized and legal-sized crabs in vented PE-mesh pots will vary between seasons and regions.

8 ANALYSES OF RELATED DATA ON THE GIANT MUD CRAB (*Scylla serrata*) FROM THE NT AND QLD

8.1 INTRODUCTION

Over the last 20 years, research and monitoring programs in the NT and Qld have caught and/or measured tens of thousands of mud crabs. Four major initiatives include the:

- NT mud crab market monitoring program (1992 to present).
- NT mud crab depletion and trapping web surveys (2002 to 2003).
- Qld Long Term Monitoring Program (LTMP) (2000 to 2009).
- Moreton Bay Marine Park (MBMP) monitoring program (2008 to present).

Much of the data collected during these programs has been published in departmental reports covering particular areas of interest (e.g. Hay et al., 2005; Jebreen et al., 2008; Ward et al., 2008; Water Quality and Aquatic Ecosystems Health, Environment and Resource Sciences, 2012). However, the sheer volume of data collected means that there are still many ways in which it can be examined. The purpose of this chapter was to summarise elements of these data sets in new and different ways relevant to the current study. Some of the information is used in the estimation of potential efficiency gains achieved through the use of escape vents (Chapter 9).

8.2 MATERIALS AND METHODS

8.2.1 *Weight at width relationships for Scylla serrata caught by commercial fishers in all areas of the NT*

Details of the NT mud crab market monitoring program are given in Section 6.2.4. Here we present the weight at width relationships for male and female *Scylla serrata* sampled from all commercial crabbing areas of the NT (as opposed to individual river systems) during this program.

8.2.2 *Comparisons of catch statistics for Scylla serrata caught in commercial wire-mesh pots set in three NT rivers*

A series of depletion and trapping web surveys targeting *S. serrata* on the Adelaide and Wearyan rivers (see Figure 5.1) were conducted between May 2002 and September 2003 (Hay et al., 2005; see Appendix 4 for sampling timetable). This study used two types of wire-mesh pots, one constructed of 25 mm x 25 mm wire mesh (referred to as “research pots”) and the other formed from 75 mm x 50 mm wire mesh (referred to as “commercial pots” and identical to the control pots used in Chapter 6). Three quarters of the pots used on the Adelaide River were research pots with the remainder being commercial pots. The proportions were reversed for trials on the Wearyan River.

We accessed this data (which is jointly owned by the NT Government and FRDC) in order to present various catch statistics for commercial wire-mesh pots used in these rivers and compare them with those derived from control pots set in the Roper River during the current study. Only those crabs that were tagged and released in the buffer zones of the depletion experiment were included in the analysis as the successive removal of larger size classes from the depletion zone resulted in the capture of progressively smaller crabs (which may not be caught under normal fishing conditions) which in turn skews the size distribution to the left.

It should be noted that the depletion and trapping web studies were conducted prior to the 10-mm increase in the MLSs for commercially-harvested mud crabs in May 2006. The impact of this change on the size

distribution of catch is not known. Hence, we stress that the size distribution of crabs inhabiting the Adelaide and/or Wearyan rivers may have changed since 2002-03. Similar to Chapter 6, the term “under-sized” refers to males <140 mm CW and females <150 mm CW, while the term “legal-sized” refers to males \geq 140 mm CW and females \geq 150 mm CW.

8.2.3 Comparisons of catch statistics for *Scylla serrata* caught in PE-mesh pots set in different regions of Qld

The mud crab component of the Qld LTMP ran from March 2000 to February 2009 and sampled from a range of locations within seven of the eight geographic regions of Qld (following Gribble, 2004; Figure 8.1). Not all locations were sampled in all years and we have pooled data from different locations within the same region. The timing and duration (days) of sampling as well as the sample size for each region and year are given in Appendix 5.

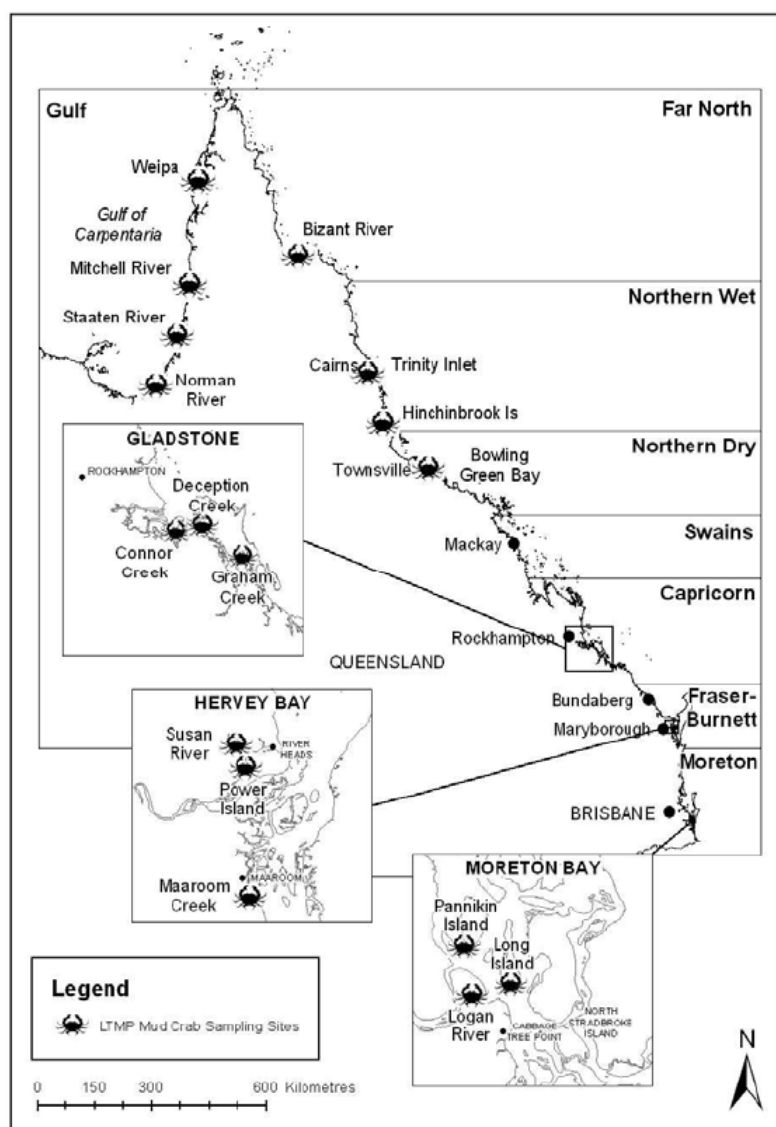

Figure 8.1. Distribution of mud crab sampling sites in Qld (from Jebreen et al., 2008; with permission)

Twenty identical, circular, collapsible, PE-mesh Munyana[®] pots (50 mm x 50 mm mesh size) were set on each sampling day and checked between 3 and 12 hours later. Each crab was sexed, measured (as CW to the nearest millimetre) and inspected for injury (loss of appendages, deformity or obvious parasites) prior to

release. Detailed accounts of the sampling protocols are given in Jebreen et al. (2008) and Fisheries Qld (2009).

Access to the LTMP data was granted through a creative commons agreement between DPIF and Qld DAFF. Similar to Chapter 7, we refer to all crabs <150 mm CW as “under-sized” and those \geq 150 mm CW as “legal-sized”, irrespective of the male only harvest policy in Qld. Mean CW within each size category and size frequency distributions (both relative and cumulative) for crabs caught in different regions are presented to determine if and how these factors differ by location.

8.2.4 Comparisons of catch statistics for *Scylla serrata* caught in PE-mesh pots set in areas open and closed to fishing in the MBMP

The MBMP was declared on 1 December 1997 and later expanded on 1 March 2009. Areas protected by the initial declaration are referred to here as “old green zones” and those projected by the subsequent declaration as “new green zones”.

Prior to the implementation of the new green zones, the Qld Department of Environment and Resource Management began the MBMP monitoring program in collaboration with a number of research partners. The main aim being to describe if and how species diversity and abundance changes in a given area when fishing pressure is removed.

The Commonwealth Scientific and Industrial Research Organisation (CSIRO) was engaged to conduct surveys of fish and invertebrates (including mud crabs) at a number of sites within the MBMP. These sites were situated within general use zones (open to fishing), old green zones and also areas about to be declared as new green zones (Figure 8.2).

Each site was sampled for a number of days during summer (January to March) and winter (July to September) from the winter of 2008 or the summer of 2009 to the present (see Appendix 6). Between 25 and 50 identical circular collapsible PE-mesh pots were set in each zone type and hauled the next day. Each crab was sexed and measured (as CW to the nearest millimetre) prior to release. A more detailed account of the sampling protocol is given in the report by Water Quality and Aquatic Ecosystems Health, Environment and Resource Sciences (2012).

It is important to note that the pots used during the MBMP monitoring were different from those set during the Moreton Bay component of the LTMP. The former were larger in diameter and had trawl mesh instead of semi-rigid plastic “gutter guard” entrances.

Access to the MBMP mud crab monitoring data was granted through a data transfer agreement between DPIF and CSIRO. Again, we refer to all crabs <150 mm CW as “under-sized” and those \geq 150 mm CW as “legal-sized”, irrespective of the male only harvest policy in Qld. Mean CW within each size category and size frequency distributions (both relative and cumulative) for crabs caught in different zones are presented to determine if and how these factors differ in the presence or absence of fishing.

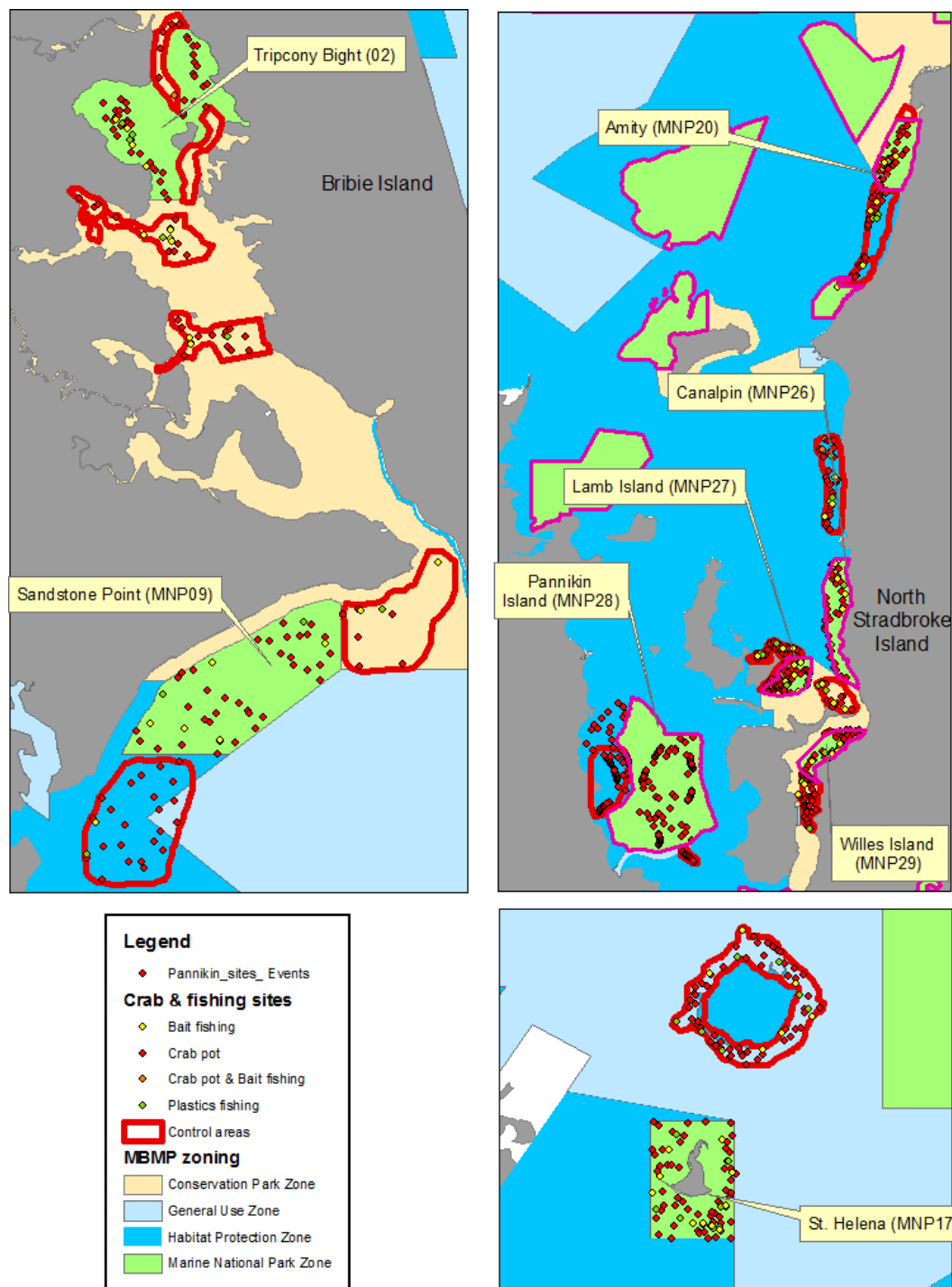

Figure 8.2. Distribution of crab sampling sites within the Moreton Bay Marine Park (MBMP), Qld. Points bound by red lines indicate sampling in areas open to fishing. The Tripcony Bight (02) and Willes Island (MNP29) sites represent old green zones. All other sites sampled (including those bound by purple lines) were in “new green zones”. Image courtesy of Richard Pillans, CSIRO.

8.3 RESULTS

8.3.1 Weight at width relationships for *Scylla serrata* caught by commercial fishers in all crabbing areas of the NT

The CW and WW of male *S. serrata* ($n = 35\,515$) sampled from the catch of commercial mud crab fishers operating in all crabbing areas of the NT ranged from 108 to 207 mm and 169 to 2070 g, respectively. Corresponding figures for females ($n = 31\,829$) were 89 to 205 mm CW and 110 to 1418 g, respectively.

The relationships between WW and CW for males and females differed and are shown in Figure 8.3. Again, the greater slope of the relationship for males is due to the allometric growth of the chelae which begins when the animal reaches about 130 mm CW (Knuckey, 1999). Likewise, much of the variability in WW for a given CW is due to the inclusion of crabs in different moult stages as well as those missing one or more appendages.

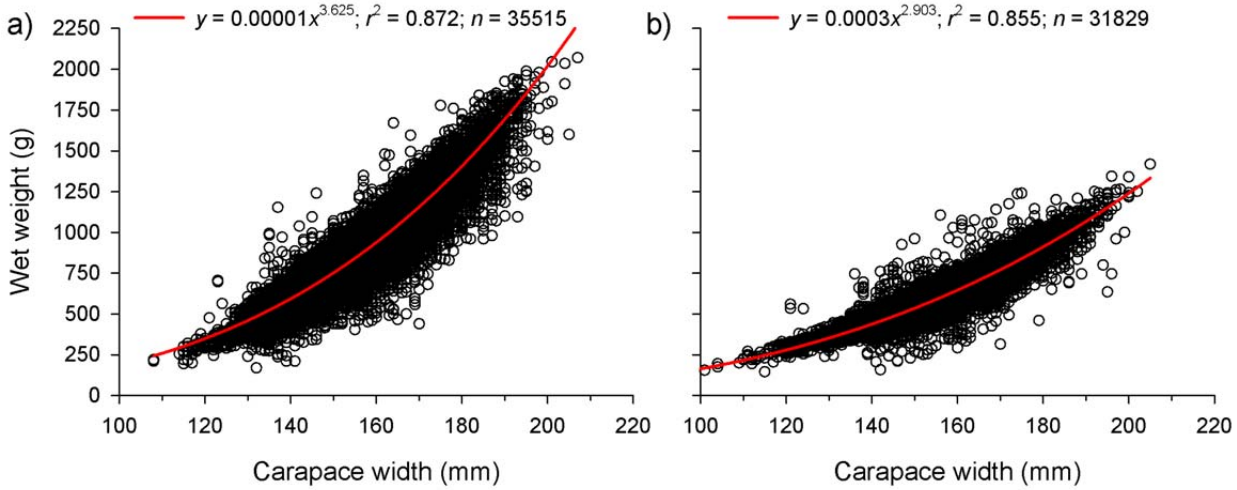

Figure 8.3. Relationships between carapace width and wet weight for a) male and b) female *Scylla serrata* sampled from the catch of commercial fishers operating in all crabbing areas of the NT

8.3.2 Comparisons of catch statistics for *Scylla serrata* caught in commercial wire-mesh pots set in three NT rivers

The overall mean CW of *S. serrata* (pooled across sex) caught in wire-mesh pots was greatest in the Wearyan River (145 mm CW) followed by the Adelaide (141 mm CW) and Roper rivers (137 mm CW), respectively (Table 8.1). The proportion of crabs above the MLS followed the same pattern. The male fraction of the catch was similar in the Roper (47%) and Wearyan rivers (51%) but higher in the Adelaide River (66%). The percentage of males above the MLS was greater than that of females at all sites.

The mean size of under-sized males and females ranged from 120 to 127 mm CW and 129 to 133 mm CW, respectively. Variability in the mean size of legal-sized crabs was lower, ranging from 154 to 156 mm CW for males and 157 to 160 mm CW for females.

Table 8.1. Summary statistics for *Scylla serrata* caught in unvented commercial wire mesh pots set in the Wearyan and Adelaide rivers in 2002-03 and the Roper River in 2010-11. Minimum legal sizes (MLSs) are 140 mm carapace width (CW) for males (♂) and 150 mm CW for females (♀). Values in parentheses are sample sizes.

Region	Sex	Mean CW (mm)			
		Overall	<MLS	≥MLS	% ≥MLS
Wearyan	Pooled	145 (1187)	130 (534)	156 (653)	55%
	♂	146 (606)	127 (187)	154 (419)	69%
	♀	143 (581)	132 (347)	160 (234)	40%
	%♂	51%	35%	64%	-
Adelaide	Pooled	141 (364)	126 (188)	157 (176)	48%
	♂	141 (239)	125 (112)	156 (127)	53%
	♀	141 (125)	129 (76)	160 (49)	39%
	%♂	66%	60%	72%	-
Roper	Pooled	137 (104)	128 (68)	156 (36)	35%
	♂	136 (49)	120 (27)	155 (22)	45%
	♀	139 (55)	133 (41)	157 (14)	25%
	%♂	47%	40%	61%	-

Size frequency distributions for male *S. serrata* caught in the Wearyan (Figure 8.4a) and Adelaide rivers (Figure 8.4c) were unimodal, while the corresponding distributions for females caught in these rivers were bimodal (Figures 8.4b and 8.4d, respectively). Modes for both sexes caught in the Roper River were less distinct (Figures 8.4e and 8.4f). Unimodal curves were a better fit to the data than bimodal curves, but did not accurately reflect the size distribution of either sex; a possible reason being the relatively small number of crabs caught in unvented wire-mesh pots set in the Roper River.

Catch curves for *S. serrata* caught in the three NT river systems showed the same general shape, but were slightly different. The cumulative frequency of under-sized males was greatest in the Roper River followed by the Adelaide or Wearyan rivers (Figure 8.5a). The same pattern was also true for under-sized females, although the differences between rivers were not as great as those observed for males, particularly for the Adelaide and Wearyan rivers (Figure 8.5b).

The catch curves for each system pooled across sex (Figure 8.5c) separated at 110 mm CW. Curves for the Adelaide and Wearyan rivers then coalesced at 155 mm CW and merged with the curve for the Roper River at 170 mm CW. This pattern emerged because of the lesser fraction of large (>150 mm CW) crabs caught in the Roper River relative to the other systems.

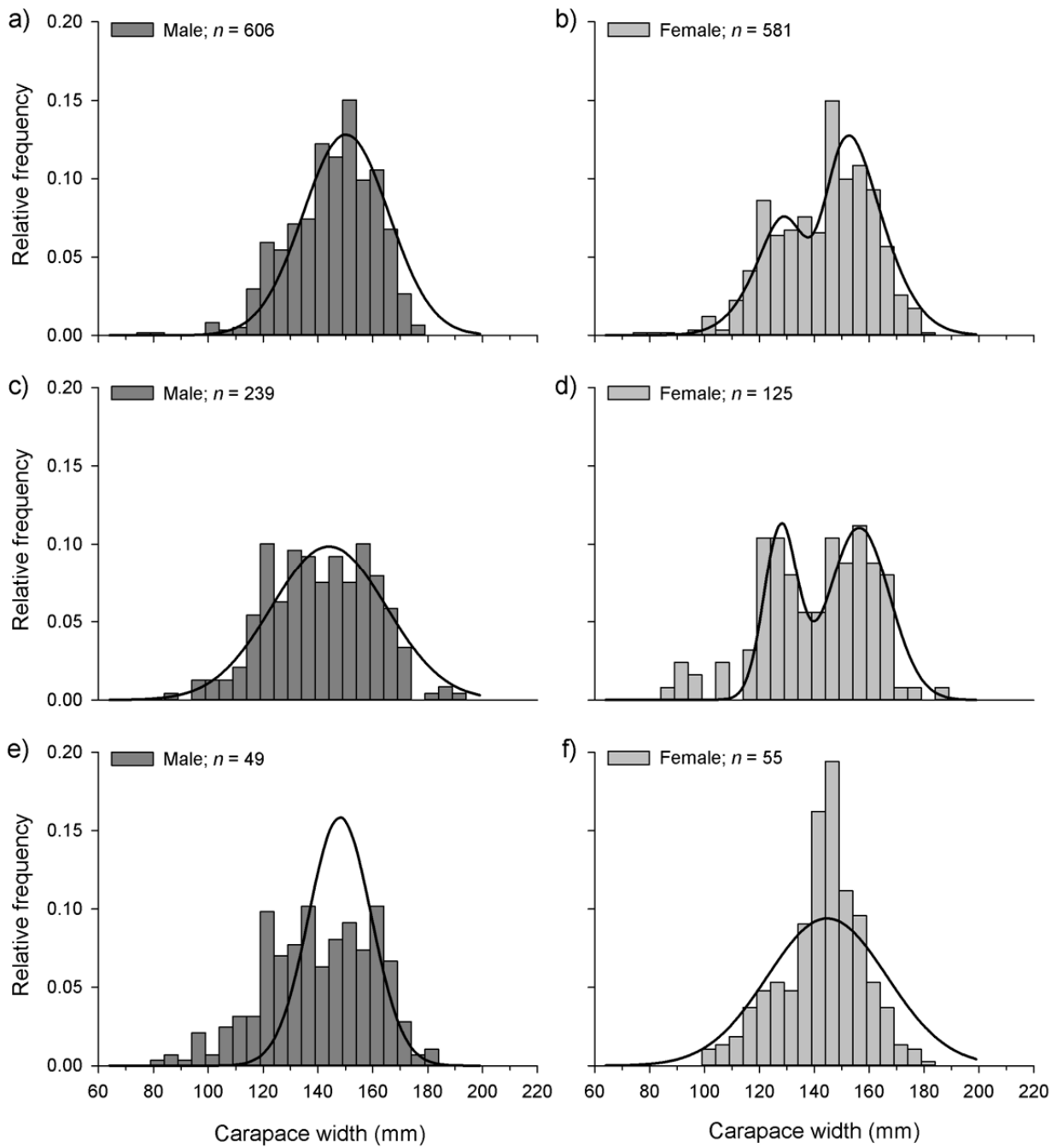

Figure 8.4. Relative size frequencies of male (left) and female (right) *Scylla serrata* caught in unvented commercial wire-mesh pots set in the Wearyan (a,b) and the Adelaide rivers (c,d) in 2002-03 and the Roper River (e,f) in 2010-11. Upper bin values for each 5-mm size category end with 4 or 9. Parameter values and correlation coefficients for Gaussian curves given in Appendix 3.

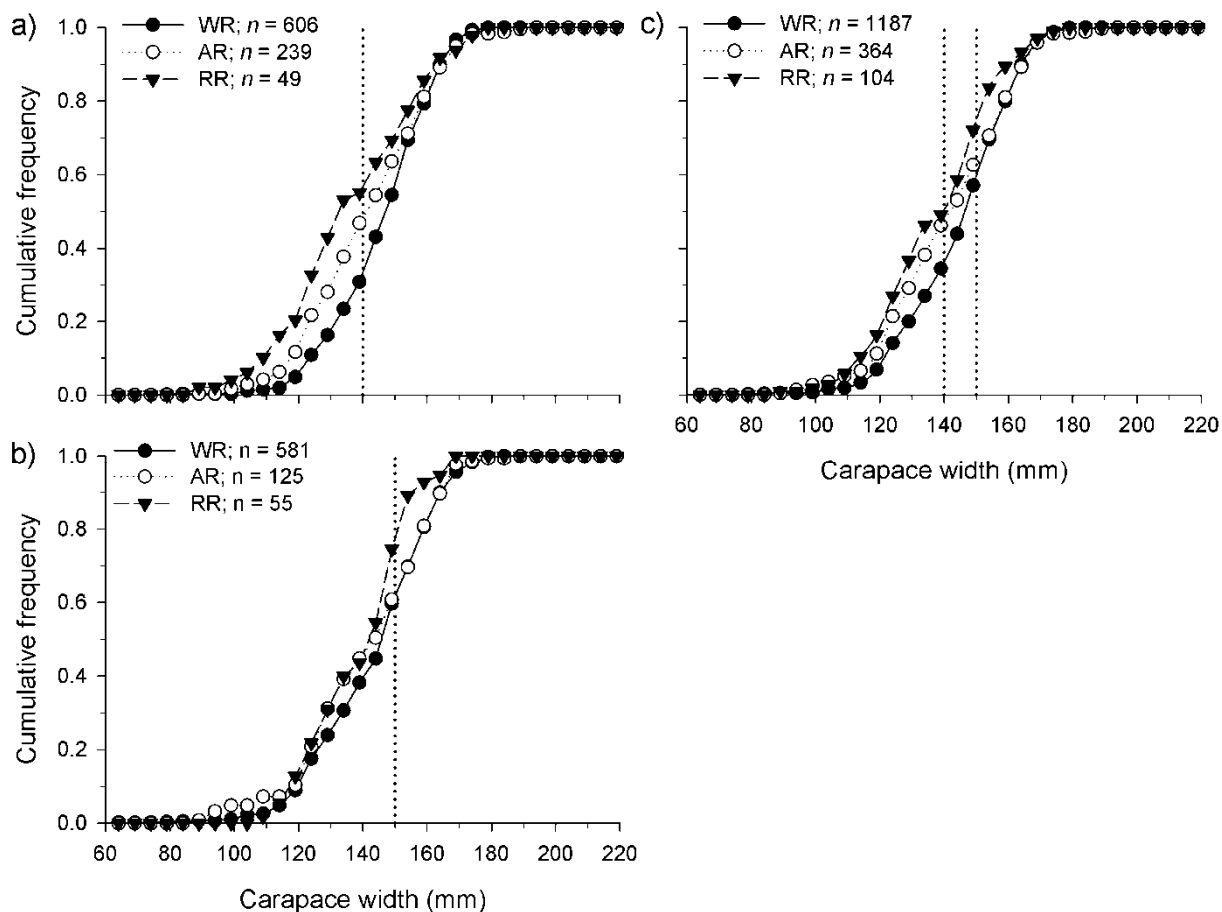

Figure 8.5. Cumulative size frequency of *Scylla serrata* caught in unvented commercial wire-mesh pots set in the Wearyan River (WR) and Adelaide River (AR) in 2002-03 and the Roper River (RR) in 2010-11. Plots a) and b) show data for males and females, respectively. Plot c) shows data for both sexes combined. Upper bin values for each 5-mm size category end with 4 or 9. The left and right dotted vertical lines show minimum legal sizes for male and female *S. serrata* harvested by the NT commercial mud crab fishery, respectively.

8.3.3 Comparisons of catch statistics for *Scylla serrata* caught in PE-mesh pots set in different regions of Qld

The mean CW of *S. serrata* (sexes pooled) caught in different regions of Qld ranged from 129 to 152 mm CW, with the mean for all regions combined being 139 mm CW (Table 8.2). There was no apparent relationship between average CW and latitude. The mean CW of under-sized females was less than that of under-sized males in all regions. By contrast, the average CW of legal-sized females was generally the same or slightly higher than that of legal-sized males in all but one region (presumably due to the male only harvest policy in Qld).

The proportion of males in regional catches ranged from 39 to 85%, with the overall value (pooled across regions) being 58%. Males typically dominated the catch of under-sized crabs while females dominated that of legal-sized crabs; again, most likely due to the male only harvest policy in Qld.

Table 8.2. Summary statistics for *Scylla serrata* caught in polyethylene-mesh pots set in the Gulf of Carpentaria (GOC), far north (FN), northern wet (NW), northern dry (ND), Capricorn (CAP), Fraser-Burnett (FB) and Moreton Bay (MOR) regions of Qld (where the minimum legal size [MLS] = 150 mm carapace width [CW] for males, noting that female crabs below this size will also use escape vents). ALL = all regions combined. Values in parentheses are sample sizes.

Region	Sex	Mean CW (n)			
		Overall	<MLS	≥MLS	% ≥MLS
GOC	Pooled	136 (1577)	119 (953)	163 (624)	40%
	♂	139 (1110)	122 (638)	163 (472)	43%
	♀	130 (467)	114 (315)	163 (152)	33%
	%♂	73%	52%	76%	-
FN	Pooled	133 (766)	125 (573)	159 (193)	25%
	♂	134 (648)	125 (482)	160 (166)	26%
	♀	130 (118)	122 (91)	157 (27)	23%
	%♂	85%	84%	86%	-
NW	Pooled	137 (1475)	123 (964)	162 (511)	35%
	♂	133 (650)	124 (495)	161 (155)	24%
	♀	139 (825)	122 (469)	162 (356)	43%
	%♂	44%	51%	30%	-
ND	Pooled	142 (1983)	135 (1298)	157 (685)	35%
	♂	141 (1471)	135 (1051)	157 (420)	29%
	♀	146 (512)	134 (247)	157 (265)	52%
	%♂	74%	81%	61%	-
CAP	Pooled	152 (2062)	131 (893)	167 (1169)	57%
	♂	142 (802)	133 (549)	163 (253)	32%
	♀	158 (1260)	129 (344)	169 (916)	73%
	%♂	39%	61%	22%	-
FB	Pooled	142 (1899)	131 (1164)	164 (735)	39%
	♂	138 (907)	132 (714)	161 (193)	21%
	♀	150 (992)	131 (450)	166 (542)	55%
	%♂	48%	61%	26%	-
MOR	Pooled	129 (2881)	122 (2352)	162 (529)	18%
	♂	125 (1717)	123 (1606)	157 (111)	6%
	♀	135 (1164)	119 (746)	163 (418)	36%
	%♂	60%	68%	21%	-
ALL	Pooled	139 (12643)	126 (8197)	163 (4446)	35%
	♂	135 (7305)	127 (5535)	160 (1770)	24%
	♀	144 (5338)	124 (2662)	164 (2676)	50%
	%♂	58%	68%	40%	-

Mean CWs and % ≥MLS in bold are referred to in Tables 9.1 and 9.3, respectively

The fraction of legal-sized crabs in the catch ranged from 18 to 57% depending on region. The proportion of legal-sized females was greater than that of legal-sized males in all but two regions (GOC and the far north). The proportion of legal-sized males caught in Moreton Bay was particularly low (6%). The overall percentage of legal-sized males and females (pooled across regions) was 24% and 50%, respectively.

Size frequency distributions for *S. serrata* caught in different regions of Qld (Figures 8.6 and 8.7) showed both similarities and differences. Some distributions were relatively “flat” with small proportions of crabs

across many size classes (e.g. Figures 8.6a and 8.6b), while others showed clearly defined peaks with many crabs in fewer size classes (e.g. Figure 8.6h).

The size frequency distributions for males were unimodal in all regions except the GOC (Figure 8.6a) where there was a weak bimodal signal. Size frequency distributions for females ranged from weak bimodal in the far north (Figure 8.6d), to strong bimodal in the northern dry (Figure 8.6h), to trimodal in the GOC (Figure 8.6a).

Knife-edge selection of legal-sized males (≥ 150 mm CW) was evident in the Capricorn and Fraser-Burnett regions (Figures 8.7a and 8.7c) but not in Moreton Bay (Figure 8.7e). The reason for this is unclear as sampling in Moreton Bay was conducted in general use zones (that are open to fishing) as opposed to green zones, where fishing is prohibited (Jason McGilvray, pers. comm.).

Catch curves for crabs caught in the GOC and northern wet regions (pooled across sex) were quite similar, whereas those for crabs caught in other regions of Qld differed by varying degrees (Figures 8.8a-b). When the data was pooled across regions (Figure 8.8c), most males (76%) and exactly half of the females were under-sized.

When the data was plotted by region (Figures 8.9 and 8.10) it was clear that the cumulative frequency of under-sized males was greater than that of under-sized females for all but the GOC and far north regions. The obvious "steps" in the catch curves for females (e.g. Figures 8.9a and 8.10c) arose from the bimodal size frequency distributions for this sex.

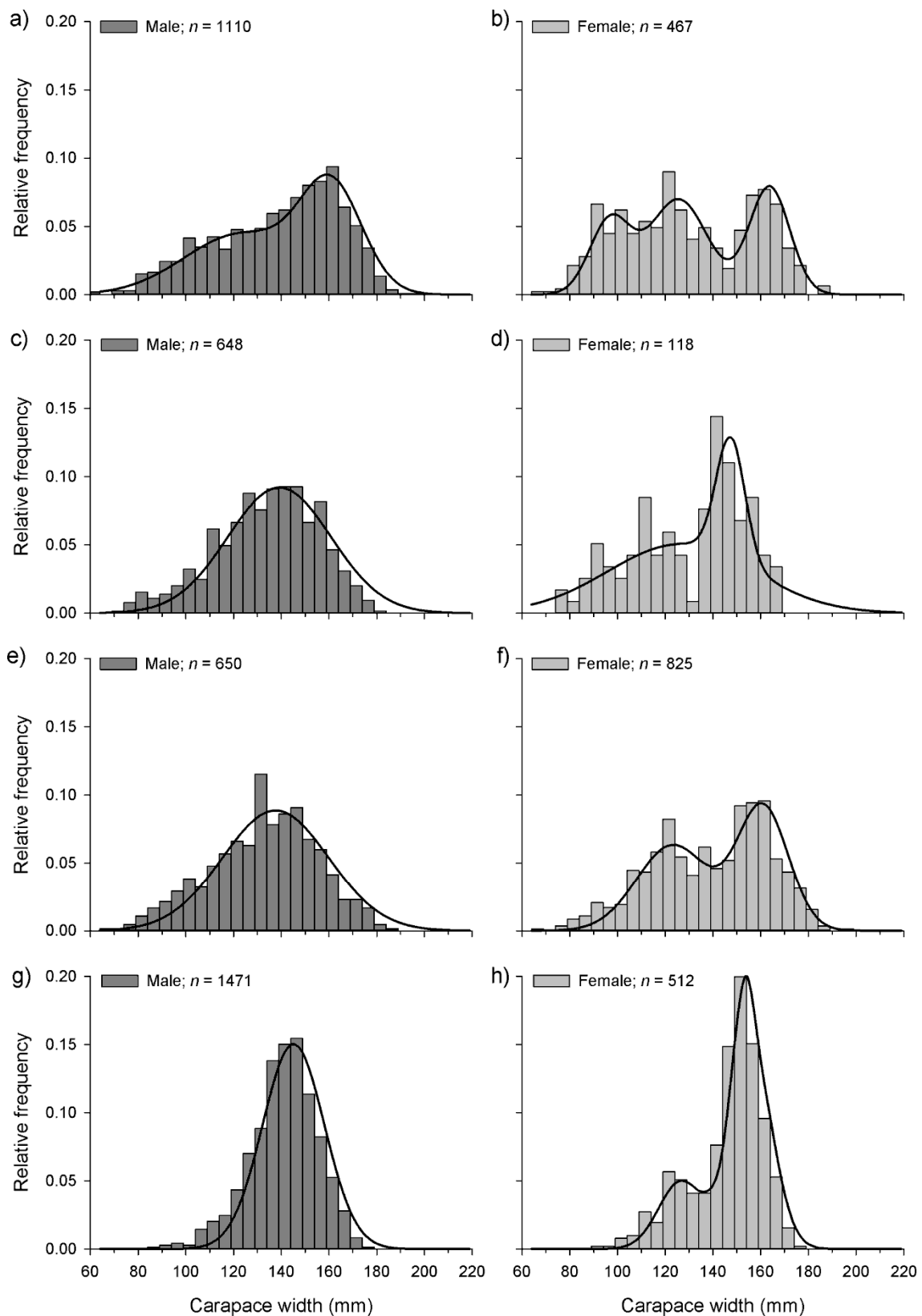

Figure 8.6. Relative size frequency of male (left) and female (right) *Scylla serrata* caught in polyethylene-mesh pots set in the Gulf of Carpentaria (a,b), the far north (c,d), the northern wet (e,f) and the northern dry (g,h) regions of Qld. Upper bin values for each 5-mm size category end with 4 or 9. Parameter values and correlation coefficients for Gaussian curves given in Appendix 3.

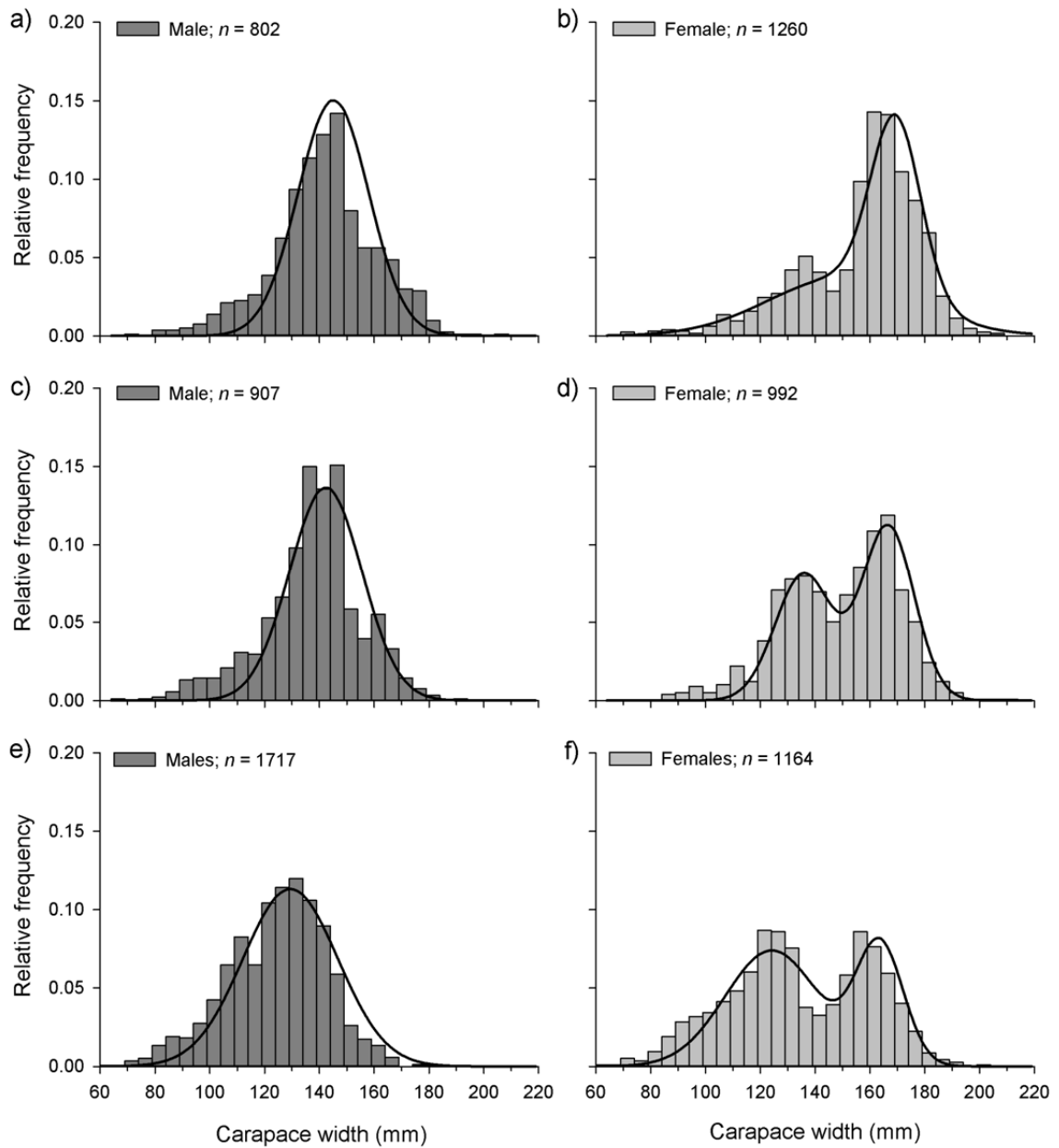

Figure 8.7. Relative size frequency of male (left) and female (right) *Scylla serrata* caught in polyethylene-mesh pots set in the Capricorn (a,b), Fraser-Burnett (c,d) and Moreton Bay (e,f) regions of Qld. Upper bin values for each 5-mm size category end with 4 or 9. Parameter values and correlation coefficients for Gaussian curves given in Appendix 3.

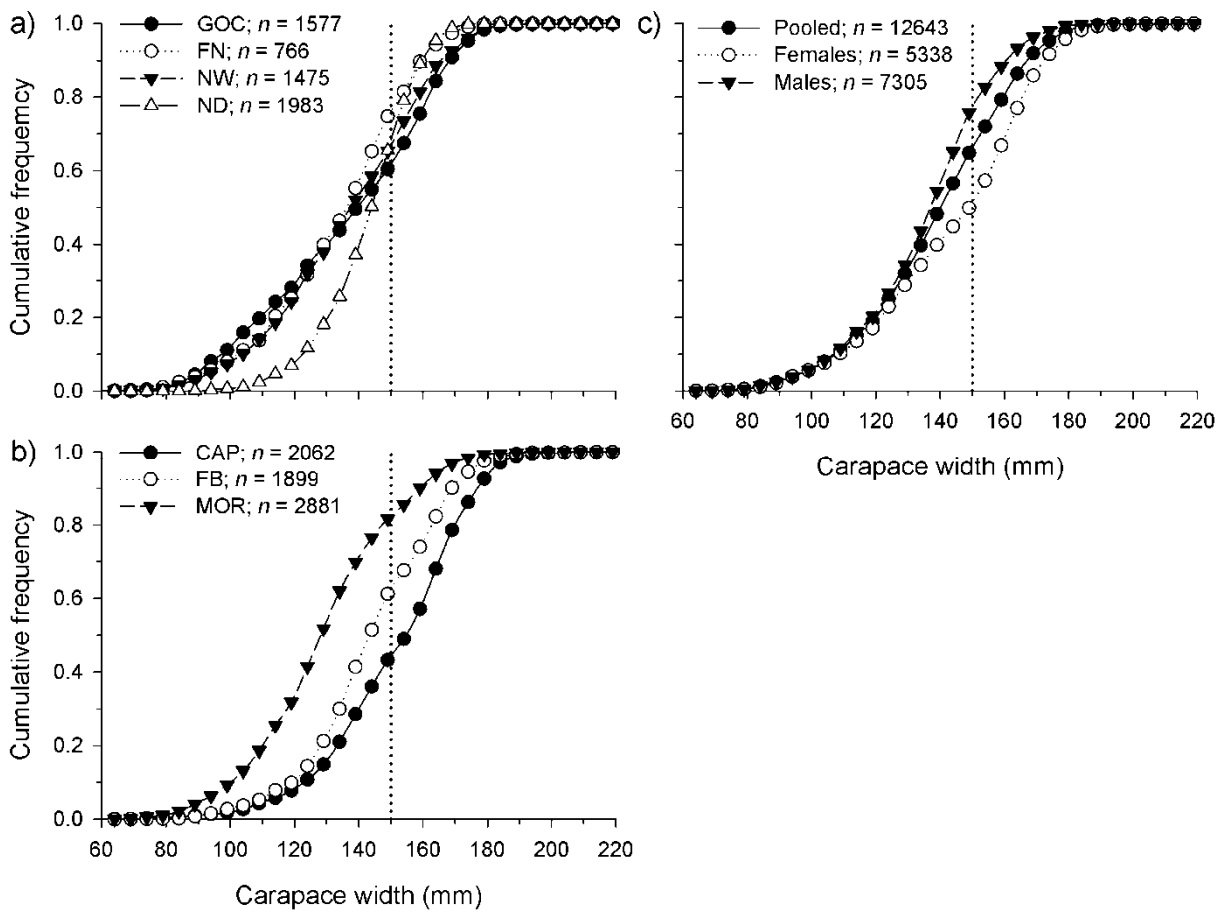

Figure 8.8 Cumulative size frequency of *Scylla serrata* caught in polyethylene-mesh pots set in the Gulf of Carpentaria (GOC), far north (FN), northern wet (NW), northern dry (ND), Capricorn (CAP), Fraser-Burnett (FB) and Moreton Bay (MOR) regions of Qld. Plots a) and b) show data (pooled across sex) for northern and southern regions, respectively. Plot c) shows pooled and sex specific data for all areas combined. Upper bin values for each 5-mm size category end with 4 or 9. The dotted vertical line shows the minimum legal size for males harvested by the Qld mud crab fishery.

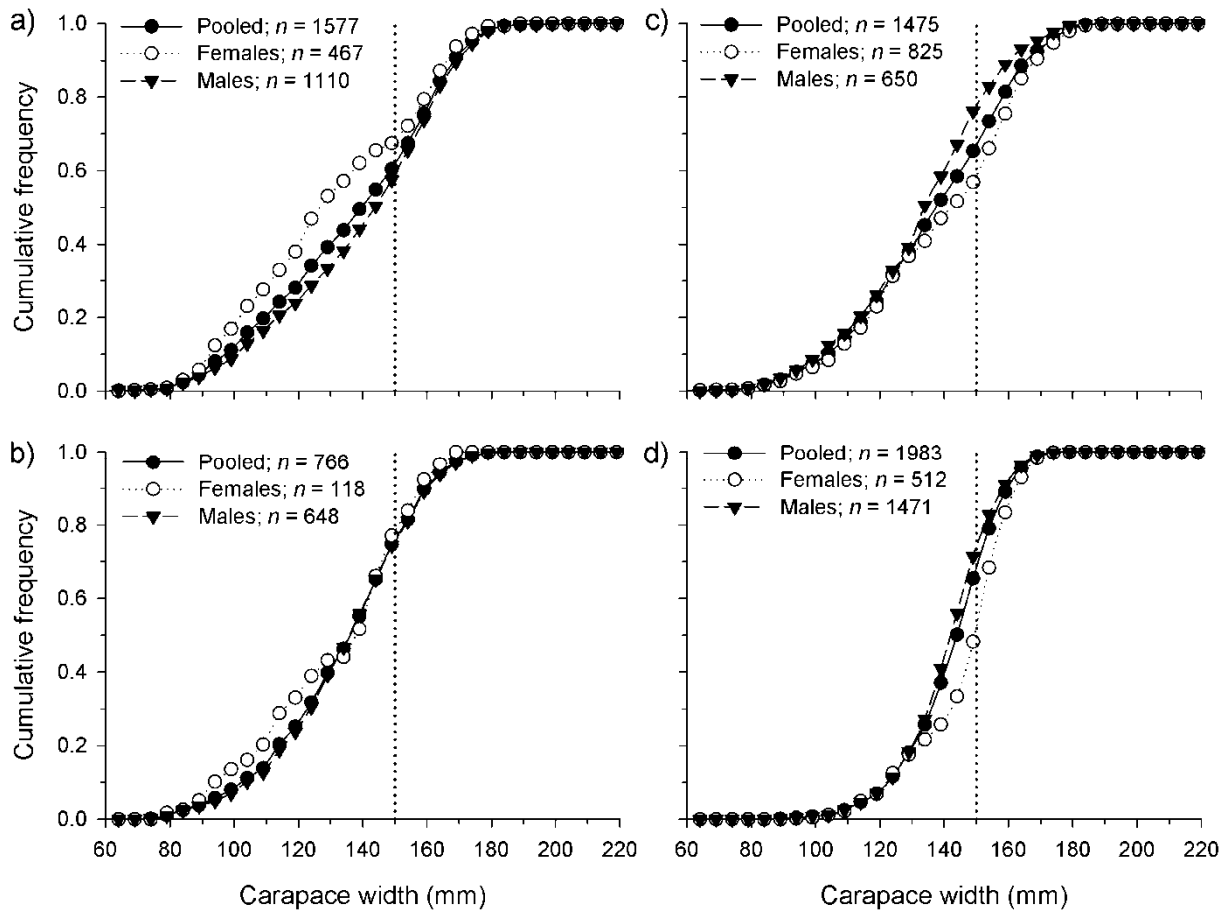

Figure 8.9. Pooled and sex-specific cumulative size frequency of *Scylla serrata* caught in polyethylene-mesh pots set in a) the Gulf of Carpentaria, b) the far north, c) the northern wet and d) northern dry regions of Qld. Upper bin values for each 5-mm size category end with 4 or 9. The dotted vertical line shows the minimum legal size for males harvested by the Qld mud crab fishery.

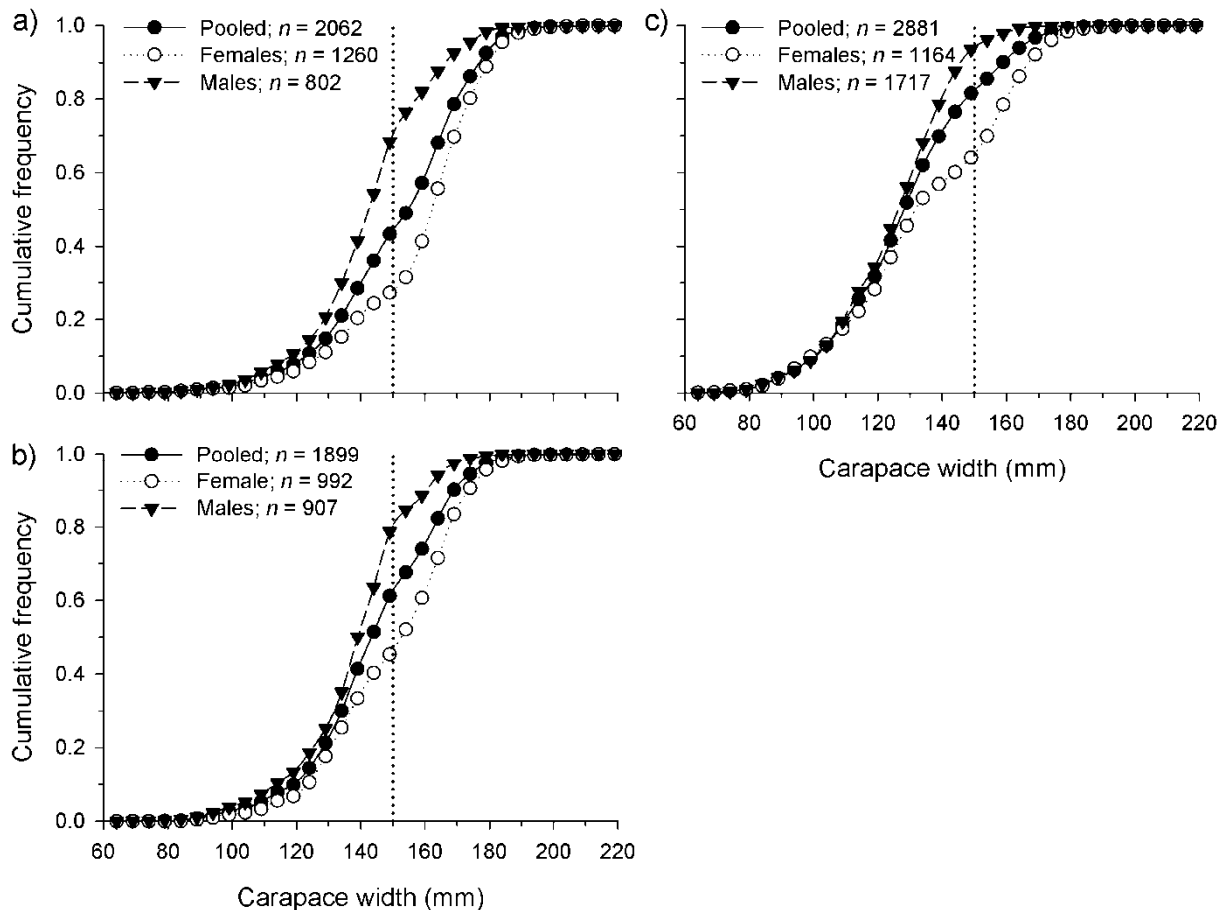

Figure 8.10. Pooled and sex-specific cumulative size frequency of *Scylla serrata* caught in polyethylene-mesh pots set in a) the Capricorn, b) the Fraser-Burnett and c) the Moreton Bay regions of Qld. Upper bin values for each 5-mm size category end with 4 or 9. The dotted vertical line shows the minimum legal size for males harvested by the Qld mud crab fishery.

8.3.4 Comparisons of catch statistics for *Scylla serrata* caught in PE-mesh pots set in areas open and closed to fishing in the MBMP

Both the pooled and sex-specific mean CW of *S. serrata* were lowest in the general use zone (open to fishing) and progressively increased in the new and old green zones, respectively (Table 8.3). Likewise, the gap between the overall mean CW of males and females decreased relative to the length of area closure. Both the proportion of males and the proportion of legal-sized crabs (of both sexes) increased when the areas were closed. Of particular note is the fact that the fraction of legal-sized males (relative to all legal-sized crabs) rose from 29% in the general use zone to 64% in the old green zone.

Table 8.3. Summary of catch statistics for *Scylla serrata* caught in polyethylene-mesh pots set in areas open (general use zone) and closed to fishing (new and old green zones) in the Moreton Bay Marine Park, Qld (where the minimum legal sizes [MLS] = 150 mm carapace width [CW] for males, noting that female crabs below this size will also use escape vents). Values in parentheses are sample sizes.

Status	Sex	Mean CW (mm)			
		Overall	<MLS	≥MLS	% ≥MLS
General use zone	Pooled	145 (2195)	128 (1247)	167 (948)	43%
	♂	137 (1098)	128 (827)	162 (271)	25%
	♀	152 (1097)	126 (420)	169 (677)	62%
	%♂	50%	66%	29%	-
New green zone	Pooled	150 (2134)	130 (942)	166 (1192)	56%
	♂	146 (1247)	131 (668)	163 (579)	46%
	♀	155 (887)	127 (274)	168 (613)	69%
	%♂	58%	71%	49%	-
Old green zone	Pooled	160 (712)	134 (196)	170 (516)	72%
	♂	160 (471)	137 (143)	170 (328)	70%
	♀	161 (241)	126 (53)	170 (188)	78%
	%♂	66%	73%	64%	-

Similar to the results of the mud crab component of the LTMP, the size frequency distributions for the MBMP mud crab monitoring program were unimodal for males and bimodal females (Figure 8.11). The modal size class for males caught in Moreton Bay during the LTMP (130 to 134 mm; Figure 8.7e) was 15 mm less than that for males caught in the general use zone of the MBMP (145 to 149 mm; Figure 8.11a), such that knife-edge selection of males was more evident in the latter data set.

The relative frequency of small female crabs (which constitute the left mode in the size frequency distributions) diminished relative to the length of area closure (Figures 8.11b, 8.11d and 8.11f). This is not to say that small female crabs are less common in green zones, just that they are less likely to enter pots because of the capture of many more large crabs in these zones. Depletion experiments (where all crabs are removed, stored, then released at completion) over the course of a week or more would provide a clearer picture as to the number/density of crabs in different size classes relative to fishing activity/length of area closure.

Catch curves for males caught in general use, new and old green zones were very different (Figure 8.12a) whereas those for females were quite similar (because females are not harvested in Qld; Figure 8.12b). In both cases (and also when the data was pooled; Figure 8.12c), the cumulative frequency of under-sized crabs was greatest in the general use zone followed by the new and old green zones, respectively. Again, the obvious “steps” in the selectivity curves for females arose from the bimodal size frequency distributions for this sex.

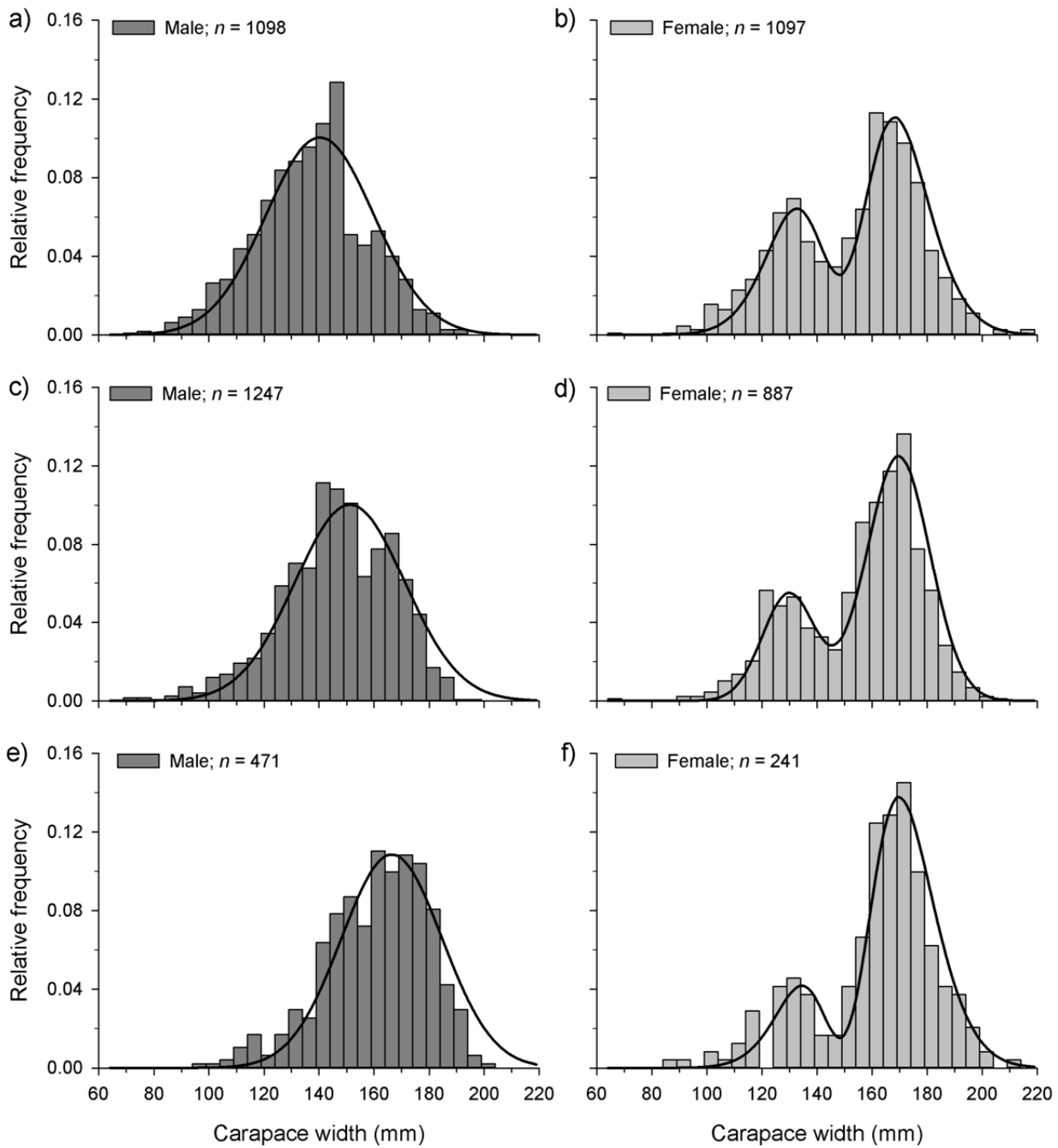

Figure 8.11. Relative size frequencies of male (left) and female (right) *Scylla serrata* caught in polyethylene-mesh pots set in areas of the Moreton Bay Marine Park (a,b) open to fishing, (c,d) closed to fishing since 1 March 2009 and (e,f) closed to fishing since 1 December 1997. Upper bin values for each 5-mm size category end with 4 or 9. Parameter values and correlation coefficients for Gaussian curves given in Appendix 3.

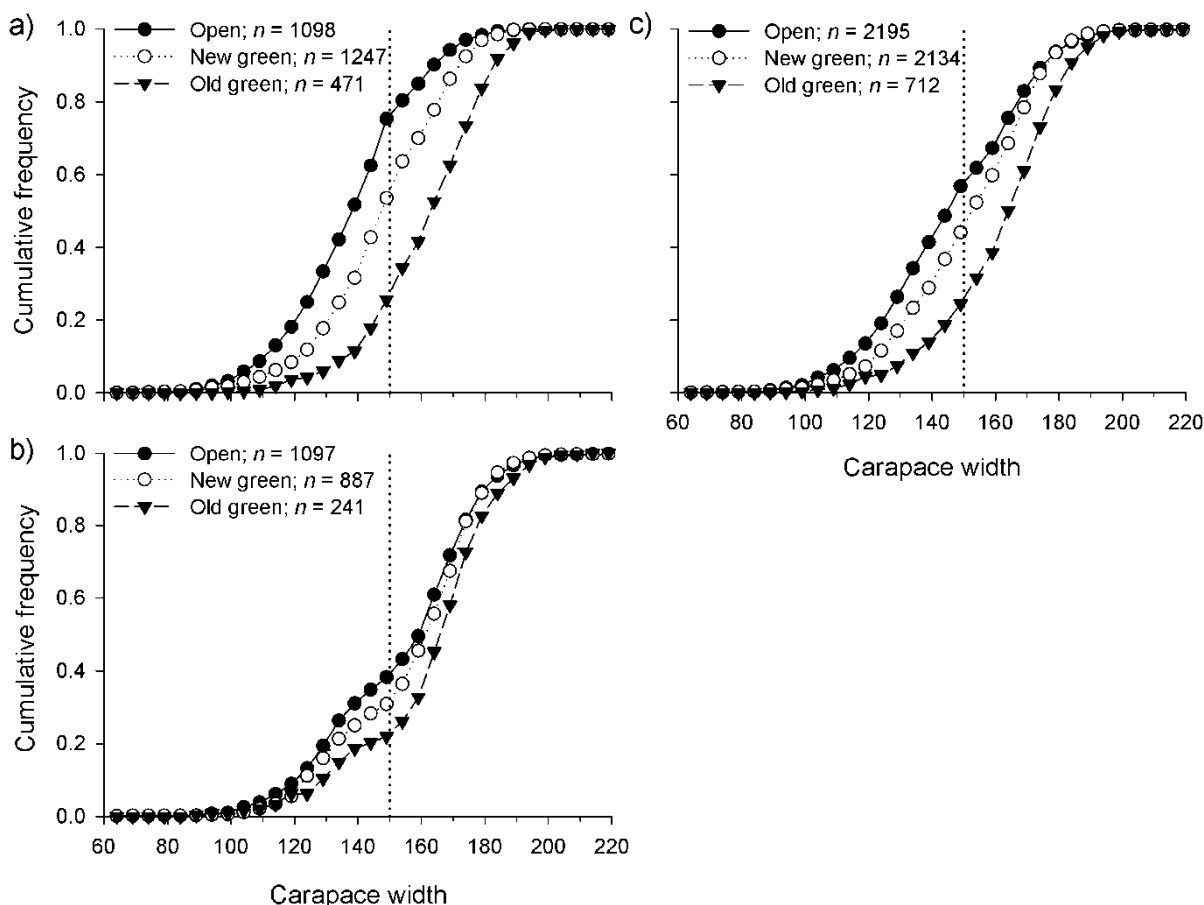

Figure 8.12. Cumulative size frequency of *Scylla serrata* caught in polyethylene-mesh pots in areas of the Moreton Bay Marine Park open to fishing (Open), closed to fishing since 1 March 2009 (New green) and closed to fishing since 1 December 1997 (Old green). Plots a) and b) show data for males and females, respectively. Plot c) shows data for both sexes combined. Upper bin values for each 5-mm size category end with 4 or 9. The dotted vertical line shows the minimum legal size for males harvested by the Qld mud crab fishery.

8.4 DISCUSSION

The coefficients and exponents for the power relationships between CW and WW for *S. serrata* caught in the Adelaide and Roper rivers (Figures 7.6 and 6.5, respectively) and all commercial crab fishing areas combined (Figure 8.3) were similar within sex but differed between sexes (Table 8.4). Males grow rapidly heavier as they become wider, as evidenced by the high width-weight exponent (~ 3.6 ; Figure 8.3a) whereas females maintain a near standard allometric pattern (exponent ~ 3 ; Figure 8.3b).

Comparable differences in the CW x WW relationships for male and female *S. serrata* were illustrated by Heasman (1980) who plotted data from his own work (in Moreton Bay) as well as that from Thailand (Varikul et al., 1972), South Africa (Du Plessis, unpublished data) and Madagascar (Le Reste et al., 1976). While Heasman (1980) did not present the actual regression relationships, it is clear from his plots that the exponents were greater for males than females in all cases.

Similar to our results for PE-mesh pots (Chapter 7), the mean CW of *S. serrata* caught (by Hay et al., 2005) in wire-mesh pots set in the Adelaide River was greater than that of crabs caught in identical pots set in the Roper River during our study (Table 8.1). However, the mean size of crabs caught in wire-mesh pots set in the Adelaide River in 2002-03 (141 mm CW) was less than that of crabs caught in PE-mesh pots set in the

same system eight years later (155 mm CW). A possible reason for the latter observation being the 10 mm increase in the MLSs for commercially harvested mud crabs in 2006.

Table 8.4. Coefficients, exponents and sample sizes (*n*) for weight at width relationships for male (♂) and female (♀) *Scylla serrata* caught by commercial fishers in the Adelaide and Roper rivers and all sampling areas of the NT pooled

Location	Sex	Coefficient	Exponent	<i>n</i>
Adelaide River	♂	0.000008	3.655	8181
	♀	0.0002	2.979	10 525
Roper River	♂	0.000007	3.697	9227
	♀	0.0003	2.897	5165
All NT pooled	♂	0.00001	3.625	35 515
	♀	0.0003	2.903	31 829

Size frequency distributions for male mud crabs caught in different regions during the Qld LTMP were generally unimodal, with knife-edge selection at 150 mm CW (the Qld MLS for this sex) evident in some cases. Corresponding distributions for females showed moderate to strong bimodality and in one case (the GOC, Figure 8.6b) there appeared to be three modes.

Similar results (multi-modal size distributions) for *S. serrata* sampled from Qld were reported by Heasman (1980). This author described three modes for both males (at 121 mm, 142 mm and 165 mm CW) and females (at 127 mm, 167 mm and 193 mm CW) caught in Moreton Bay. The greater number of modes reported by Heasman (1980) is likely due to the fact that he used a combination of external characteristics (“growth phases”) and size to separate individuals whereas we used size alone because growth phase was not recorded during the LTMP.

The mean CW of males caught in the MBMP increased relative to the length of area closure (Figure 8.11). However, there was no apparent change in the position of the modes for females caught in the closed area. The latter observation is not unexpected given that the harvest of female mud crabs in Qld is prohibited.

The proportion of legal-sized males caught in the general use zone (open to fishing) during the MBMP monitoring program (25%; Table 8.3) was over four times greater than the equivalent value for the same zone obtained during the LTMP sampling in Moreton Bay (6%; Table 8.2). This may be the result of the different types of pots used in the two studies.

The semi-rigid gutter guard funnels fitted to the LTMP pots may provide more purchase for smaller crabs attempting to enter this pot type. If these pots then become saturated with small crabs, this could explain the apparent lack of larger crabs in the LTMP catch data. Pots with trawl-mesh funnels (as used in the MBMP monitoring program) may select against smaller crabs as they might find it more difficult to negotiate flexible mesh compared with gutter guard. Clearly, further testing of the effect funnel configurations on the size distribution of the catch is required to prove or disprove this hypothesis.

The fact that the two studies in Moreton Bay sampled in different seasons and different years may also have a bearing on the size distribution of the catches. Mean monthly sizes of commercially-harvested mud crabs in the NT show consistent sinusoidal patterns across years (Grubert et al., 2013). If similar patterns occur in Qld (at least for male mud crabs) then sampling in different months could affect the size-distributions. Similarly, the commercial catch rate of mud crabs in northern Australia is correlated with rainfall and the Southern Oscillation Index (Meynecke et al., 2012a; 2012b), introducing another source of variation when sampling.

The results presented in this chapter highlight the existence of regional differences in the size structure of *S. serrata* populations in northern Australia. They also illustrate the impacts of different harvest policies (both sexes, male only or prohibited harvest) on these populations in terms of the sex ratio and size structure of the catch.

9 POTENTIAL EFFICIENCY GAINS OF FITTING ESCAPE VENTS TO POTS USED BY NT AND QLD MUD CRAB FISHERIES

9.1 INTRODUCTION

Potential efficiency gains (in terms of reduced handling of under-sized crabs and/or increased catch of legal-sized crabs) derived through the use of escape vents in mud-crab pots can be estimated using a range of catch statistics. These include: the total catch/harvest (by weight or numbers), the harvest/release fractions (as a percentage of the total catch/harvest), mean sizes and weights of under-sized and legal-sized crabs, the sex ratio of the catch/harvest and the relative difference in catch rates of under-sized and legal-sized crabs in vented pots compared to that in conventional (unvented) pots. The aim of this chapter is to provide estimates of these efficiency gains (based on data presented in previous chapters) for commercial and recreational mud crab fisheries in the NT and Qld.

9.2 MATERIALS AND METHODS

Mud-crab harvest data from commercial fisheries is expressed by weight whilst catch and harvest estimates for recreational fisheries are expressed by numbers. Hence, the procedures used to calculate potential efficiency gains from the use of escape vents by each sector differed. One point of similarity is that all following examples assume a 1:1 sex ratio for catches of both under-sized and legal-sized crabs over the course of the fishing season. We acknowledge that this may not occur in reality given the wide ranging estimates of the proportion of males in each size category presented in previous chapters but have chosen to use an even sex ratio for the purposes of simplicity.

The first step in calculating the reduction in handling of under-sized crabs in commercial fisheries (where the number of crabs caught/harvested is not known) was to determine the mean CW of under-sized and legal-sized crabs caught in unvented pots relative to the different MLSs used in Qld and the NT. This information was derived from fishery-independent sampling undertaken during this work and the Qld LTMP (Tables 6.4, 7.4 and 8.2).

Mean CW values were substituted into the corresponding weight at width relationship to derive mean WWs for each sex, size category and fishery. Note that the functions were applied to the mean CW values only, not the entire CW data sets from Qld or NT (because of uneven sample sizes and unequal sex ratios in these data sets).

Estimates for the NT and Qld commercial fisheries (Table 9.1) were calculated from the weight at width relationships for crabs sampled from all regions during the NT commercial catch monitoring program (Figure 8.3). because we are unaware of any contemporary estimates of the weight at width relationships for mud crabs caught in Qld. The annual tonnages for the commercial fisheries were then divided by the pooled (for the NT) or sex-specific (for Qld) WWs, to yield an estimate of the total number of crabs harvested.

The second step in the process was to extrapolate the number of crabs caught from the reciprocal of the harvest fraction for each fishery. The harvest fraction was the proportion of legal-sized crabs in the catch derived from fishery-independent sampling (Table 9.2). The number of crabs released was then calculated by subtracting the number harvested from the number caught.

The third step was to multiply the number of crabs released by the catch rate of under-sized crabs in vented pots as a proportion of that in unvented pots (the CRC values; Table 9.3). The resultant values represent the difference in the number of under-sized crabs handled when using vented pots. The final step was to multiply the previous estimates by the mean WW of under-sized crabs to yield the handling reduction in tonnes.

Table 9.1. Mean carapace width (CW) (mm) and corresponding estimated wet weight (WW) (kg) of under-sized and legal-sized male (♂) and female (♀) *Scylla serrata* caught in unvented wire-mesh pots and unvented polyethylene-mesh pots set in the NT and Qld, respectively. Values in bold are referred to in Tables 9.6 to 9.9.

Location	Sex/size category (CW)	Mean CW for sex/size category	Estimated WW (kg) for sex/size category ³	Mean WW (kg) for size category
NT ¹	♂ <140	120	0.34	0.39
	♀ <150	133	0.44	
	♂ ≥140	155	0.87	0.79
	♀ ≥150	157	0.71	
Qld ²	♂ <150	127	0.42	0.39
	♀ <150	124	0.36	
	♂ ≥150	160	0.98	0.89
	♀ ≥150	164	0.80	

¹ mean CW data from Table 6.4 (rounded to integers); Roper River, 75 mm x 50 mm wire-mesh pots

² mean CW data from Table 8.2 (rounded to integers); from Qld Long Term Monitoring Program, 50 mm x 50 mm polyethylene-mesh pots

³ using $y = 0.00001x^{3.625}$ for males and $y = 0.0003x^{2.903}$ for females from Figure 8.3

Table 9.2. Harvest fractions of *Scylla serrata* caught in unvented pots set in the NT and Qld. Values in bold are referred to in Tables 9.6 and 9.8.

Location	Sex and minimum legal size (carapace width)	Number under-sized	Number legal-sized	Legal-sized (%) (harvest fraction)
NT ¹	♂ 140 mm	27	22	45
	♀ 150 mm	41	14	25
Qld ²	♂ 150 mm	5535	1770	24
	♀ 150 mm	2662	2676	50

¹ catch data from Table 6.4; Roper River, 75 mm x 50 mm wire-mesh pots

² catch data from Table 8.2; from Qld Long Term Monitoring Program, 50 mm x 50 mm polyethylene-mesh pots

Table 9.3. Estimates of the catch rate of under-sized crabs in treatment pots relative to that in control pots (the catch relative to control [CRC]) for three different escape vent (EV) sizes (suited to the NT recreational, NT commercial and Qld mud crab fisheries from left to right, respectively). All treatments used two escape vents per pot. Values in bold are referred to in Tables 9.6 to 9.9.

EV size; W x H	120 mm x 42 mm ¹		110 mm x 46 mm ²		120 mm x 50 mm ³		
	Sex and size category (CW)	Male <130 mm	Female <140 mm	Male <140 mm	Female <150 mm	Male <150 mm	Female <150 mm
Sex specific CRC		-24%	-23%	-18%	0%	-42%	-37%
Overall CRC		-23%		-3%		-40%	

¹ from Table 7.4; Adelaide River, 25 mm x 25 mm polyethylene-mesh pots

² mean values for three treatments from Table 6.4; Roper River, 75 mm x 50 mm wire-mesh pots

³ from Table 7.6: Adelaide River, 25 mm x 25 mm polyethylene-mesh pots

For recreational fisheries, where the number of mud crabs caught/harvested has been estimated (through recreational fishing surveys), the process was much simpler. The total catch was multiplied by the release fraction to yield the number of crabs released. This number was then multiplied by the CRC value for the particular vent size to calculate the difference in the number of under-sized crabs handled when using vented pots. The difference in handling by numbers was then converted to weight by multiplying through by the mean weight of under-sized crabs (pooled across sex for the NT and males only for Qld).

The mean WW estimate for under-sized males caught by the Qld recreational fishery was obtained by substituting the mean CW for this group into the weight at width relationships for males sampled from all areas during the NT commercial catch monitoring program (Table 9.1). By contrast, WW estimates for under-sized crabs (of both sexes) caught by the NT recreational fishery (Table 9.4) were derived from the weight at width curves for crabs sampled from commercial catches in the Adelaide River only (Figure 7.6). This data set was used in preference to that from all regions as roughly 80% of recreational mud crab harvest in the NT occurs within a 40-km radius of Darwin, which includes the Adelaide River (West et al., 2012).

Changes in the harvest of legal-sized crabs were calculated by multiplying current harvest estimates (by weight or numbers) by the CRC values for legal-sized crabs in vented pots (Table 9.5).

Table 9.4. Mean carapace width (CW) and corresponding estimated wet weight (WW) of under-sized and legal-sized *Scylla serrata* (as per the minimum legal sizes for the NT recreational fishery) caught in unvented, polyethylene-mesh pots set in the Adelaide River. The value in bold is referred to in Table 9.7.

Sex and size category (CW)	Mean CW (mm) for sex/size category ¹	Estimated WW (g) for sex/size category ²	Mean WW (kg) for size category
♂ <130 mm	106	215	0.26
♀ <140 mm	119	309	
♂ ≥130 mm	161	1009	0.89
♀ ≥140 mm	163	769	

¹ mean CW data from Table 7.4 (rounded to integers); Adelaide River, 25 mm x 25 mm polyethylene-mesh pots

² using $y = 0.000007x^{3.697}$ for males and $y = 0.0003x^{2.897}$ for females from Figure 7.6

Table 9.5. Estimates of the catch rate of legal-sized crabs in treatment pots relative to that in control pots (the catch relative to control [CRC]) for three different escape vent (EV) sizes (suited to the NT recreational, NT commercial and Qld mud crab fisheries from left to right, respectively). All treatments used two escape vents per pot.

EV size; W x H	120 mm x 42 mm ¹		110 mm x 46 mm ²		120 mm x 50 mm ³		
	Sex and size category (CW)	Male ≥130 mm	Female ≥140 mm	Male ≥140 mm	Female ≥150 mm	Male ≥150 mm	Female ≥150 mm
Sex specific CRC		4%	9%	5%	60%	29%	-17%
Overall CRC		6%		26%		9%	

¹ from Table 7.4; Adelaide River, 25 mm x 25 mm polyethylene-mesh pots

² mean values for three treatments from Table 6.4; Roper River, 75 mm x 50 mm wire-mesh pots

³ from Table 7.6; Adelaide River, 25 mm x 25 mm polyethylene-mesh pots

9.3 RESULTS

9.3.1 The NT commercial mud crab fishery

The potential reduction in handling of under-sized crabs (<140 mm CW for males and <150 mm CW for females) achieved by fitting two, 110 mm x 46 mm (W x H) escape vents to wire-mesh pots (mesh size 75 mm x 50 mm – as used by the NT commercial fishery) is presented in Table 9.6. This example, based on an annual commercial harvest of 400 t (just below the five year average of 417 t; NT Government, 2012) suggests that the handling reduction of males would be around 56 000 individuals or 19 t (just below 5% of the annual commercial harvest by weight). The mean CRC value for females was zero, meaning that the catch rate of under-sized females was the same in vented and unvented pots (the treatment did not decrease the catch rate of under-sized females).

Given an assumed handling time of 3 seconds per under-sized crab, eliminating 56 000 individuals from the sorting process (through industry-wide adoption of escape vents) could save the NT commercial fishery about 46.7 hours of labour. We have not attempted to convert this (or the following example for the Qld commercial fishery) to a monetary value as (to the best of our knowledge) fishers are invariably paid according to the weight of their catch as opposed to an hourly wage.

The use of two 110 mm x 46 mm escape vents also had an impact on the catch rate of legal-sized crabs, although its effect differed between sexes. The mean CRC for legal-sized females was 60% (from Table 9.5) whilst that for legal-sized males was just 5%. The overall increase in catch rate of legal-sized crabs (weighted by the greater catch of legal-sized males) was 26%. Factoring this into the example for the NT commercial fishery would see the annual harvest rise to 504 t (400 t x 1.26).

Table 9.6. Potential efficiency gains (in terms of the difference in handling of under-sized crabs) of fitting two, 110 mm x 46 mm (W x H) escape vents to wire-mesh pots (mesh size 75 mm x 50 mm) when the annual commercial harvest is 400 tonnes. Minimum legal sizes in this example are 140 mm carapace width (CW) for males and 150 mm CW for females. The abbreviations U/S and L/S refer to under-sized and legal-sized crabs, respectively. Numbers and weights of crabs are rounded to the nearest multiple of 100.

Annual harvest (kg)		400 000
Total crabs harvested	÷ 0.79 kg per L/S crab ^a	506 300
Males harvested	x 50% of total harvest	253 200
Males handled	x 2.23 (1 ÷ 45% male harvest fraction ^b)	562 600
Males released	– males harvested	309 400
Difference in U/S males	x -18% CRC of U/S males ^c	-55 700
Difference in U/S males (kg)¹	x 0.34 kg per U/S male ^a	-18 900
Females harvested	x 50% of total harvest	253 200
Females handled	x 4.0 (1 ÷ 25% female harvest fraction ^b)	1 012 800
Females released	– females harvested	759 600
Difference in U/S females	x 0% CRC of U/S females ^c	0
Difference in U/S females (kg)²		0
Overall Difference in U/S crabs (kg)¹⁺²		-18 900

^a from Table 9.1

^b from Table 9.2

^c from Table 9.3

9.3.2 The NT recreational mud crab fishery

The potential reduction in handling of under-sized crabs (<130 mm CW for males and <140 mm CW for females) achieved by fitting two, 120 mm x 42 mm (W x H) escape vents to PE-mesh pots (mesh size 25 mm x 25 mm – as used by some NT recreational mud crab fishers), is presented in Table 9.7. This example, based on an annual recreational catch of 81 200 individuals (derived from West et al., 2012; see Appendix 7 for derivations) suggests that the handling reduction would be around 6900 individuals or 1.8 t. This represents an 8% decrease in numbers relative to the catch and a 13% decrease in numbers relative to the harvest (of 51 200 crabs).

The use of two 120 mm x 42 mm escape vents also resulted in small increases in the catch rate of both sexes of legal-sized crabs, with the overall proportion (weighted by number caught for each sex) being 6% (from Table 9.5). Factoring this into the example for the NT recreational fishery would see the annual harvest rise to about 54 300 individuals (51 200 x 1.06).

Table 9.7. Potential efficiency gains (in terms of the difference in handling of under-sized [U/S] crabs) of fitting two, 120 x 42 mm escape vents (W x H) to polyethylene-mesh pots (mesh size 25 mm x 25 mm) when the annual recreational catch is 85 000 crabs. Minimum legal sizes in this example are 130 mm carapace width (CW) for males and 140 mm CW for females. Numbers and weights of crabs are rounded to the nearest multiple of 100.

Annual catch^a		81 200
Number of crabs released	x 37% release fraction ^a	30 000
Difference in U/S crabs	x -23% CRC of U/S crabs ^b	-6 900
Difference in U/S crabs (kg)	x 0.26 kg per U/S crab^c	-1 800

^a derived from West et al., 2012

^b average catch relative to control (CRC) for both sexes of U/S crabs caught in 2x 42mm pots; from Table 9.3

^c from Table 9.4

9.3.3 The Qld commercial mud crab fishery

The potential reduction in handling of under-sized crabs (<150 mm CW) achieved by fitting two, 120 mm x 50 mm (W x H) escape vents to PE-mesh pots (mesh size 50 mm x 50 mm – as used by many Qld commercial mud crab fishers) is presented in Table 9.8. This example, based on an annual male harvest of 1000 t, just below the five-year average of 1033 tonnes (Qld Government, 2011) suggests that the handling reduction would be around 1 360 000 individual males or 571 t (57% of the annual male harvest by weight). The handling reduction of “under-sized” females (those <150 mm) under the same scenario would be around 810 000 individuals or 291 t (29% of the annual male harvest by weight).

Given an assumed handling time of 3 seconds per under-sized crab, eliminating 2 170 000 individuals (sexes combined) from the sorting process (through industry wide adoption of escape vents) could save the Qld commercial fishery about 1808 hours of labour.

The use of two 120 mm x 50 mm escape vents also had an impact on the catch rate of legal-sized crabs although its effect differed between sexes. The CPUE of legal-sized females decreased by 17% (from Table 9.5), while that for legal-sized males increased by 29%. Factoring this into the example for the Qld commercial fishery would see the annual harvest of males rise to 1290 t (1000 t x 1.29) and the handling of legal-sized females drop by 170 t. Hence, the overall reduction in handling of non-legal crabs (all females and under-sized males) would be in the order of 1032 t (170 t + 291 t + 571 t).

Table 9.8. Potential efficiency gains (in terms of the difference in handling of under-sized crabs) of fitting two, 120 x 50-mm escape (W x H) vents to polyethylene-mesh pots (mesh size 50 mm x 50 mm) when the annual commercial harvest of males is 1000 t. The minimum legal size in this example is 150 mm carapace width (CW). The abbreviations U/S and L/S refer to under-sized and legal-sized crabs, respectively. The term "U/S females" is used as females <150 mm CW also use escape vents. Numbers and weights of crabs are rounded to the nearest multiple of 100.

Annual male harvest (kg)		1 000 000
Males harvested	÷ 0.98 kg per L/S male ^a	1 020 400
Males handled	x 4.17 (1 ÷ 24% male harvest fraction ^b)	4 255 000
Males released	– males harvested	3 234 600
Difference in U/S males	x -42% CRC of U/S males	-1 358 500
Difference in U/S males (kg)¹	x 0.42 kg per U/S male ^a	-570 600
Females handled	= number of males handled	4 255 000
Females released	x 50% (1 – 50% female harvest fraction ^b)	2 127 500
Difference in U/S females	x -38% catch relative to control of U/S females	-808 500
Difference in U/S females (kg)²	x 0.36 kg ^a per U/S female	-291 000
Overall difference in U/S crabs (kg)¹⁺²		-861 600

^a from Table 9.1

^b from Table 9.2

^c from Table 9.3

9.3.4 The Qld recreational mud crab fishery

The potential reduction in handling of under-sized crabs (<150 mm CW) achieved by fitting two, 120 mm x 50 mm (W x H) escape vents to PE-mesh pots (mesh size 50 mm x 50 mm – as used by many Qld recreational mud crab fishers) is presented in Table 9.9. This example, based on an annual recreational catch of 2 763 000 males (from McInnes, 2008), suggests that the handling reduction will be around 850 000 individuals or 332 t. This represents a 31% decrease in numbers relative to the male catch and a 133% decrease in numbers relative to the male harvest (of 638 000 individuals).

Table 9.9. Potential efficiency gains (in terms of the difference in handling of under-sized [U/S] crabs) of fitting two, 120 mm x 50 mm (W x H) escape vents to polyethylene-mesh pots (mesh size 50 mm x 50 mm) when the annual recreational catch of males is 2 763 000 individuals. The minimum legal size in this example is 150 mm carapace width. Numbers and weights of crabs are rounded to the nearest multiple of 100.

Annual male catch^a		2 763 000
Total crabs released	x 77% release fraction ^a	2 125 000
Difference in U/S crabs	x -40% CRC of U/S crabs ^b	-850 000
Difference in U/S crabs (kg)	x 0.39 kg per U/S crab ^c	-331 500

^a from McInnes, 2008

^b average catch relative to control (CRC) for both sexes of U/S crabs caught in 2x50 mm pots; from Table 9.5

^c from Table 9.4

The use of two 120 mm x 50-mm escape vents also had an impact on the catch rate of legal-sized crabs, although its effect differed between sexes. The CPUE of legal-sized females decreased by 17% (Table 9.5), while that for legal-sized males increased by 29%. Factoring this into the example for the Qld recreational fishery would see the annual harvest of males rise to 823 000 individuals (638 000 males x 1.29) and the handling of legal-sized females dropping by around 108 500 individuals (638 000 females x 17%). Hence,

the overall reduction in handling of non-legal crabs (all females and under-sized males) would be in the order of 440 000 individuals (331 500 + 108 500).

9.4 DISCUSSION

The examples provided here (derived using catch/harvest estimates and associated CRC values, the latter being percentage terms) suggest that the use of escape vents can decrease the retention of under-sized mud crabs by several thousand to several hundred thousand individuals (or kg) depending on the MLS for the fishery and the local harvest strategy (male only vs. both sex harvest). The use of these devices can also increase the catch of legal-sized crabs by similar orders of magnitude. However, it should be noted that each catch statistic used in the process of calculating potential efficiency gains from installing escape vents is subject to variation and that the process also relies on a number of assumptions.

The most notable of these assumptions is that of an even sex ratio for both under-sized and legal-sized crabs over the course of the fishing season. Tables 8.1 to 8.3 show that the proportion of under-sized males in the catch can range from 35% to 84%, equivalent to sex ratios of 0.54:1 to 5.25:1 (M:F). Likewise, the proportion of legal-sized males in the catch can range from 21% to 86%, equivalent to sex ratios of 0.27:1 to 6.14:1 (M:F). These wide variations in sex ratio are primarily due to sampling programs being restricted to a particular month (or months) when one or the other sex dominates the catch. Regular (at least monthly) fishery-independent monitoring over at least one calendar year is required to verify the overall sex ratio for both under-sized and legal-sized crabs.

A second assumption, which relates to the calculations for Qld only, is that the effect of fitting escape vents of a given size is the same for both 25 mm x 25 mm PE-mesh pots (from which the CRC estimates were derived) and 50 mm x 50 mm PE-mesh pots (on which the Qld harvest fraction estimates were based). We believe this to be a reasonable assumption given that the selectivity of unvented pots made from either mesh size is likely to be similar. We base this assertion on the fact that both meshes are under tension (particularly near the top and bottom of the pots), which in turn creates very small apertures that retain all but the smallest of mud crabs, which are rarely caught (using this gear type).

A third assumption is that all fishers in each fishery use the same pot type and mesh size as that described in the corresponding example. This is only true for the NT commercial fishery where the industry standard is wire-mesh pots with an aperture of 75 mm x 50 mm. The other fisheries use a mixture of collapsible PE-mesh pots (which may be circular or rectangular) and wire-mesh pots, with mesh size varying within each pot type. The proportion of each particular style of pot used by these fisheries is not known and so we are unable to correct for any differential effects of escape vents in the various styles of pots.

It is clear from previous chapters that there are large regional differences in mean CW of *S. serrata* in both Qld and the NT and so we stress that the harvest/release fractions (as well as the CRC values) used in the above examples will vary from place to place. Likewise, the weight at width relationships (used to calculate numbers from weights and vice versa) also showed regional variation, introducing a further source of error. These regional differences, in conjunction with the abovementioned assumptions, mean that the potential efficiency gains of fitting escape vents presented here must be viewed with a degree of caution.

10 BENEFITS AND ADOPTION

The immediate, observable benefit of fitting two appropriately-sized escape vents to mud crab pots is a reduction in the retention of under-sized crabs of up to 40% (depending on mesh size, sex and the size structure of the population) with no negative impact on overall catch rates of legal-sized crabs. In fact, catches of legal-sized animals may increase in some instances. The capture of fewer under-sized crabs will in turn reduce sorting time and increase the efficiency of commercial crabbing operations. Other, cryptic benefits may include reduced rates of i) within-pot cannibalism, ii) injury and stress and iii) post-release mortality of under-sized crabs.

There has been considerable interest in the effectiveness of escape vents since this project began. However, the relatively high cost (~\$5 each) of manufacturing the devices via laser cutting (as used during the prototyping phase) precluded widespread industry testing and adoption. Those commercial crab fishers in Qld and the NT provided with limited numbers of prototype escape vents (Table 10.1; Figure 10.1) all provided positive feedback regarding their performance and many supported the idea of industry-wide adoption.

Given the cost of laser-cutting escape vents, residual funds from this project were used to engage a plastic manufacturer (Lincoln Plastics, South Australia) to produce two sizes of escape vents via plastic injection moulding. The vents are specifically designed to fit wire-mesh pots (although they can be fitted to PE-mesh pots) and sized to retain crabs ≥ 140 mm CW or ≥ 150 mm CW.

The devices are produced using a two-piece mould, consisting of a base plate (which determines the outer dimensions) and one of two interchangeable top plates (which determine the inner dimensions (see Appendix 8 for schematics) that form a cavity into which molten plastic is injected at high pressure. Whilst machining of the mould is expensive (~\$9000) the production cost thereafter is around 50 cents per unit (10% of the previous cost).

In late 2011 and early 2012, 2000 free escape vents (1000 in each of the two sizes) were distributed to mud crab fishers in Qld (Figure 10.2) and the NT with the assistance of Gavin Leese (Fisheries observer, Qld DAFF) and local mud crab wholesalers, respectively.

One unforeseen consequence of switching from virgin PE (used in laser-cutting) to recycled polypropylene (one option for plastic injection moulding) was that the holes on the vertical sides of the escape vents formed a weak spot and the devices often snapped. This was particularly evident when the escape vents were fitted to collapsible PE-mesh pots, which offer no structural support (unlike wire-mesh pots). This problem was fixed by removing the two pins from the mould that form these holes. The notch on the left side of the escape vents (added to accommodate a wire knuckle along the edge of the pot) was also removed from the mould as it was deemed unnecessary.

Table 10.1. Names and locations of commercial mud crab fishers who tested (laser cut) prototype escape vents supplied by DPIF

Name	Jurisdiction	Location
Neil Bradley	NT	Borroloola
John Byers	Qld	Ayr
Peter Jackson	Qld	Maryborough
Shane Power	Qld	Bowling Green Bay
Tony Riesenweber	Qld	Redland Bay
Dave Swindells	Qld	Rockhampton
Peter Swindells	Qld	Gold Coast
Vu Van Nguyen	NT	Port Roper
Tam Van Nguyen	NT	Port Roper

CRAB REPORT

Gladstone crisis will worry all crab fishermen

FIRSTLY, I would like to welcome Geoff Tilton as our newly elected President and am looking forward to working with him. I know he is trying to be accessible to all fishers, to benefit the fishing industry as a whole.

Nothing to report on Future Management Plan for Crab. This is very frustrating, as we are now the only fishery with an "Investment Warning" hanging over our heads.

On Gladstone, all fishers in Queensland would have a sincere emotional concern for what our fellow fishers there are going through. They or someone they know may have gone through a similar circumstances with GBRMPA or Marine Parks. It seems the Gladstone Port Corporation or the Queensland Government has little regard for the what the fishers or other related business are going through.

Many are struggling to pay everyday expenses now.

What have we got to look forward to, if or when other port developments are going to be proposed? There is no consideration for "food security" for the present or the future when government departments plan these facilities. Seafood is a staple part of the average person's diet, and considered by many medical health professionals as a vital part of everyone dietary needs.

These are my personal opinions but I believe many fishermen are as frustrated as I am about the issues facing us and the lack of conciliation with us from the government. There are now fishers who are forced to find employment with the same development projects that are destroying their working future, lifestyle and family life.

On a lighter note, for sometime now myself, Dave Swindles and other mud crabbers have been trialing "Undersize Mud Crab Escape Vents" in pots, developed by the NT Crab Fishery. Mark Grubert, Senior Fisheries Scientist, Coastal Research Unit, Fisheries approached us to do the trial.

We found these devices did a good job at reducing the numbers of small

mud crabs in pots. The interaction with water rats was reduced and it assisted in reducing bycatch, leaving only large mud crab. I would like anyone interested in trialing these devices to please contact myself or Dave Swindles and we can put you in touch with Mark Grubert, who will advise on availability.

Also, we have been trialing "Negative Buoyancy Rope". No leads are required and it is only slightly higher in price than sea green rope. It reduces the interaction with turtles, which is an environmental plus. If you require any further information, please contact me.

I would like to urge all fishermen, personally, to put in submissions to Fisheries Minister Craig Wallace regarding his comments regarding taking of female mud crab by recreational fishers only. Again, it is the commercial fisherman who is being discriminated against. The more reaction he receives from commercial fishermen, the better. The QSIA is putting in a submissions based on the fact that no changes can take place until the management plan is finalised and in place.

Tony Riesenweber
Chair
QSIA Crab Committee



This is one of the undersize mud crab escape vents (seen in close-up at top right) that have been tested in Queensland recently.

10 — Queensland Seafood 2011 Number 6

Figure 10.1 Article by Tony Riesenweber promoting the use of escape vents in Qld

A further 1000 modified 46 mm escape vents were produced in January 2013. Five hundred of these were distributed by the first author at the NT Mud Crab Fishery Licensee Committee AGM on 6 February 2013.

Mud crab fishery managers in all relevant jurisdictions are aware of this project and its outputs. Evaluation of mud crab escape vents is detailed in both the NT and Qld Mud Crab Fishery Status Reports for 2011 (NT Government, 2012; Qld Government, 2011) and the Mud Crab chapter of the Status of Key Australian Fish Stocks Reports 2012 (Grubert et al. 2012).

A list of presentations and other media related to the project are given in Appendix 9.

[Home](#) > [Services](#) > [News & updates](#) > **Crab pot trials to help sustainability**

Crab pot trials to help sustainability

News release | 23 April, 2012

Fisheries Queensland observers are helping commercial mud crabbers trial a new device that aims to reduce bycatch of under-sized mud crabs and potentially increase catch rates of legal-sized mud crabs.

Fisheries Queensland observer coordinator Dr Julia Davies said the mud crab escape vents are now being tested by numerous commercial fishers throughout Queensland.

"The mud crab escape vents were developed by Dr Mark Grubert and his team at the Northern Territory Fisheries Division," Dr Davies said.

"Following success in the Northern Territory, Fisheries Queensland is working with fishers to trial the vents in the Queensland crab fishery.

"Results from the Northern Territory showed a reduction in the catch rate of under-sized crabs of up to 40% and an increase in catch rate of legal-sized males of up to 30%, so we're hoping to see a similar result for Queensland fishers.

"There are also other benefits, such as juvenile crabs can exit pots without being damaged or cannibalised by other crabs.

"Fewer under-sized crabs in pots also means less handling and post-release mortality, which is good for both crabs and crabbers."

This trial is just one way in which the Fisheries Queensland observer program is assisting commercial fishers to reduce bycatch and improve their profitability.

"The observer program is a great way for commercial fishers to find out industry information and about new tools that can assist them in their operations," Dr Davies said.

"Fisheries observers monitor commercial fishing operations when they are taken onboard during fishing trips to collect data about catch, discards and any interactions with species of conservation interest. They also help fishers by providing information on best practice methods.

"We are keen to have more commercial fishers volunteer for the program so they can participate in trials of new technology and help inform fisheries management decisions through sharing their fishing experiences."

If you are interested in becoming a part of the Fisheries Observer Program and taking part in the mud crab escape vent trial, please contact Fisheries Queensland on 13 25 23.

Media contact: Louise Gillis, +61 7 3224 8799

» [Louise Gillis](#)

 [Print friendly](#)

[Back to top](#) ↑

Figure 10.2. Media release from Qld Department of Agriculture, Fisheries and Forestry regarding testing of escape vents by commercial crabbers in that state

11 FURTHER DEVELOPMENT

Given the advanced stage reached in the mass production of injection-moulded escape vents suited to wire-mesh pots, we see little need for further development of this design. Parties may, however, wish to produce similar escape vents with intermediate or larger gaps, in which case it is simply a matter of manufacturing a different top plate for the mould (at a cost of about \$1200).

While the device mentioned above can be fitted to PE-mesh pots using cable ties, we do not believe this arrangement to be optimal. We suggest an alternative design consisting of two rectangular plates, one with 8 to 10 barbed “posts” and the other with corresponding holes. The barbed plate would be placed inside the pot and the perforated plate outside the pot. They would then be aligned and locked together with the mesh inside the frame removed to allow the exit of under-sized crabs. Mass production of this style of escape vent will be pursued as time and resources allow.

12 PLANNED OUTCOMES

The planned outcome at the start of this project was legislative change to mud crab gear controls on the proviso that escape vents (or larger mesh sizes) reduced the retention of under-sized crabs by at least 20%. While this performance trigger has been met, we now believe that voluntary stakeholder evaluation of escape vents is a necessary precursor to any changes to industry codes of conduct or legislation.

This evaluation process has been underway for some time, with 3000 free escape vents having been provided to mud crab fishers in the NT and Qld. As mentioned above, problems with the first batch of injection-moulded escape vents have been rectified by changing their design slightly. Positive experiences by those fishers using the “new” escape vents are expected to translate into stakeholder-driven changes to codes of conduct and legislation within the next year or so. Indeed, NT Fisheries will be conducting a formal review of the Mud Crab Fishery Management Plan in the second half of 2013 and the fitment of escape vents will be discussed during this process.

We also expect that changes to mud crab pots that demonstrably reduce the retention of bycatch will increase the likelihood of re-accreditation of the NT and Qld mud crab fisheries as wildlife trade operations (which enables the fisheries to export product).

13 CONCLUSION

This work demonstrated that escape vents can provide a means to improve gear selectivity in Australian mud crab (*Scylla serrata*) fisheries. Pots fitted with two escape vents decreased the retention of under-sized crabs by as much as 40% (compared with unvented control pots) depending on mesh size, sex and the size structure of the population. Overall catch rates of legal-sized crabs in vented pots were (in most cases) the same or higher than those in unvented pots. While the addition of more than two escape vents led to further reductions in the catch of under-sized crabs, the catch of legal-sized crabs was compromised.

14 REFERENCES

- Boutson, A., Mahasawasde, C., Mahasawasde, S., Tunhijanukij, S., and Arimoto, T. (2009). Use of escape vents to improve size and species selectivity of collapsible pot for blue swimming crab *Portunus pelagicus* in Thailand. *Fisheries Science*, **5**:25-33.
- Brown C. G. (1982). The effect of escape gaps on trap selectivity in the United Kingdom crab (*Cancer pagurus* L.) and lobster (*Homarus gammarus* (L.)) fisheries. *Journal du conseil / Conseil international pour l'exploration de la mer*, **40**:127-134.
- Brown, I. W. (1993). Mangrove crabs. In: Wright, A., Hill, L. (Eds.) "Nearshore marine resources of the South Pacific. Institute of Pacific Studies (Suva), Forum Fisheries Agency (Honiara) and the International Centre for Ocean Development" (Canada), pp. 609-642.
- Butcher, P. A., (2004). Mud crab (*Scylla serrata*) and marine park management in estuaries of the Solitary Islands Marine Park, New South Wales. PhD Thesis, University of New England, Armidale, 290 pp.
- Butcher, P. A., Leland, J. C., Broadhurst, M. K., Paterson B. D. and Mayer, D. G. (2012). Giant mud crab (*Scylla serrata*): relative efficiencies of common traps and impacts to discards. *ICES Journal of Marine Science*, **69**:1511-1522.
- Coleman, A. P. M. (2004). The National Recreational Fishing Survey: The Northern Territory. NT Department of Business, Industry and Resource Development. Fishery Report No. 72, 93 pp. http://www.nt.gov.au/d/Content/File/p/Fish_Rep/FR72.pdf
- De Haan, W. (1833). Crustacea. In: von Siebold, P.F. (Ed.) Fauna Japonica sive Descriptio Animalium, quae in Itinere per Japoniam, Jussu et Auspiciis Superiorum, qui Summum in India Batava Imperium Tenent, Suspecto, Annis 1823-1830 Collegit, Notis, Observationibus et Adumbrationibus Illustravit: i-xxxii, ix-xvi, 1-243, Plates A-J, L-Q, 1-55. Lugduni-Batavorum.
- Eldridge, P. J., Burrell, V. G., and Steele, G. (1979). Development of a self-culling blue crab pot. *Marine Fisheries Review*, **41**:21-27.
- Faulks, J. J. (2001). An Assessment of the Physical and Ecological Condition of the Roper River and its Major Tributaries. NT Department of Lands, Planning and Environment. Technical Report No. 36/2001, 129 pp. <http://www.nt.gov.au/nreta/water/aquatic/waterways/pdf/roper/complete.pdf>
- Fisheries Queensland. (2009). Fisheries Long Term Monitoring Program Sampling Protocol – Mud Crab (2008 onwards) Section 1. Department of Employment, Economic Development and Innovation, Brisbane, 9 pp. http://www.dpi.qld.gov.au/documents/Fisheries_SustainableFishing/Mud-Crab-Samp-Protocol.pdf
- Forskål, P. (1775). Descriptiones animalium avium, amphibiorum, piscium, insectorum, vermium; quae in itinere orientali observavit Petrus Forskål. Post mortem auctoris edidit Carsten Niebuhr. Adjuncta est materia medica Kahirina atque tabula maris rubri geographica. pp. 1-20.
- Gribble, N. A. (Ed.) (2004). Tropical Resource Assessment Program Final Report (Qld inshore fish stocks): Phase I, Collation and assessment of available fisheries information. Phase II Model application and validation. FRDC 1999/125 Final Report. Qld Department of Primary Industries Information Series, 54 pp.
- Groeneveld, J. C., Khanyile, J. P. and Schoeman, D. S. (2005). Escapement of the cape rock lobster (*Jasus lalandii*) through the mesh and entrance of commercial traps. *Fishery Bulletin*, **1031**:52-62.

Grubert, M., Leslie, M. and Winning, M. (2012). Mud crab *Scylla serrata*, *S. olivacea*. In: Flood, M., Stobutzki, I., Andrews, J., Begg, G., Fletcher, W., Gardner, C., Kemp, J., Moore, A., O'Brien, A., Quinn, R., Roach, J., Rowling, K., Sainsbury, K., Saunders, T., Ward, T. and Winning, M. (Eds.), "Status of key Australian fish stocks reports 2012", Fisheries Research and Development Corporation, Canberra, pp 131-137.

http://fish.gov.au/reports/crustaceans/crabs/Pages/mud_crab.aspx

Grubert, M. A., Saunders, T. M., Martin, J. M., Lee, H. S. and Walters C. J. (2013). Stock Assessments of Selected Northern Territory Fishes. NT Government Fishery Report No. 110, 63 pp.

Guillory, V., and Hein, S. (1998). A review and evaluation of escape rings in blue crab traps. *Journal of Shellfish Research*, **17**:551-559.

Guillory, V., Allemand, R., King, K. and Bare, U. (2004). An evaluation of 5.87-cm and 6.03-cm escape rings for blue crab *Callinectes sapidus* traps. *North American Journal of Fisheries Management*, **24**:1431-1434.

Havens, K. J., Bilkovic, D. M., Stanhope, D. and Angstadt, K. (2009). Location, location, location: the importance of cull ring placement in blue crab traps. *Transactions of the American Fisheries Society*, **138**:720-724.

Hay, T. and Calogeras, C. (2000). NT Mud Crab Fishery: Summary of Assessment Information 1996-1999. Fishery Report No. 53. NT Department of Primary Industry and Fisheries, 29 pp.

http://www.nt.gov.au/d/Content/File/p/Fish_Rep/FR53.pdf

Hay, T., Gribble, N., de Vries, C., Danaher, K., Dunning, M., Hearnden, M., Caley, P., Wright, C., Brown, I., Bailey, S., and Phelan, M. (2005). Methods for Monitoring the Abundance and Habitat of the Northern Australian Mud Crab *Scylla serrata*. Fishery Report No. 80. NT Department of Business, Industry and Resource Development, 122 pp., including appendices.

http://www.nt.gov.au/d/Content/File/p/Fish_Rep/FR80.pdf

Heasman, M. P., (1980). Aspects of the general biology and fishery of the mud crab *Scylla serrata* (Forskål), in Moreton Bay, Queensland. PhD Thesis, University of Queensland, Brisbane, 506 pp.

Henry, G. W. and Lyle, J. M. (2003). The National Recreational and Indigenous Fishing Survey. FRDC Project 99/158. NSW Fisheries Final Report Series No. 48, 188 pp.

http://eprints.utas.edu.au/2526/1/Henry_Lyle_Nationalsurvey.pdf

Hyland, S. J., Hill, B. J. and Lee, C. P. (1984). Movement within and between different habitats by the portunid crab *Scylla serrata*. *Marine Biology*, **80**:57-61.

Jebreen E., Helmke S., Lunow C., Bullock C., Gribble N., Whybird, O., and Coles, R. (2008). Fisheries Long Term Monitoring Program, Mud Crab (*Scylla serrata*) Report: 2000-2002. PR08-3498. Department of Primary Industries and Fisheries, Brisbane, 24 pp.

http://www.dpi.qld.gov.au/documents/Fisheries_SustainableFishing/Mud-Crab-2000-2002-report.pdf

Jirapunpipat, K., Phomikonga, P., Yokota, M. and Watanabe, S. (2008). The effect of escape vents in collapsible pots on catch and size of the mud crab *Scylla olivacea*. *Fisheries Research*, **94**:73-78.

Keenan, C. P., Davie, P. and Mann, D. (1998). A revision of the genus *Scylla* De Haan, 1833 (Crustacea, Decapoda, Brachyura, Portunidae). *The Raffles Bulletin of Zoology*, **46**:217-245.

Knuckey, I. A. (1999). Mud crab (*Scylla serrata*) population dynamics in the Northern Territory, Australia and their relationship to the commercial fishery. PhD Thesis, Northern Territory University, Darwin, 248 pp.

- Knuckey, I. A., Davie, P. J., and Cannon, L. R. (1995). *Loxothylacus ihlei* Boschma, (Rhizocephala) and its effects on the mud crab, *Scylla serrata* (Forskål), in northern Australia. *Journal of Fish Diseases*, **18**:389-395.
- Krouse, J. S. (1978). Effectiveness of escape vent shape in traps for catching legal-sized lobster, *Homarus americanus*, and harvestable-sized crabs, *Cancer borealis* and *Cancer irroratus*. *Fisheries Bulletin*, **76**:425-432.
- Le Reste, L. Feno, L. and Rameloston, A. (1976). Etat de nos Connaissances sur le Crabe Vase *Scylla serrata* Forskal à Madagascar. (ORSTOM: Paris), 32 pp.
- Macnae, W. (1968). A general account of the fauna and flora of mangrove swamps and forests in the Indo-West-Pacific region. *Advances in Marine Biology*, **6**:73-270.
- McInnes, K. (2008). Experimental results from the fourth Queensland recreational fishing diary program (2005). PR08-3838. Department of Primary Industries and Fisheries, Brisbane, 34 pp.
http://www.dpi.qld.gov.au/documents/Fisheries_RecreationalFishing/Recreational-fishing-diary-program-2005.pdf
- Meynecke, J. O., Grubert, M. A. and Gillson, J. (2012a). Giant mud crab (*Scylla serrata*) catches and climate drivers in Australia - A large scale comparison, *Marine and Freshwater Research*, **63**:84-94.
- Meynecke, J. O., Grubert, M. A., Arthur, J. M., Boston, R., and Lee, S. Y. (2012b). The influence of the La Niña-El Niño cycle on Giant Mud Crab (*Scylla serrata*) catches in Northern Australia. *Estuarine, Coastal and Shelf Science*, **100**:93-101.
- Millar, R. B., and Fryer, R. J. (1999). Estimating the size-selection curves of towed gears, traps, nets and hooks. *Reviews in Fish Biology and Fisheries*, **9**:89-116.
- Miller, R. J. (1990). Effectiveness of crab and lobster traps. *Canadian Journal of Fisheries and Aquatic Sciences*, **47**:1228-1251.
- Mounsey, R. (1989). Northern Territory Mud Crab Fishery Investigation. NT Department of Primary Industry and Fisheries, Fishery Report No. 19. http://www.nt.gov.au/d/Content/File/p/Fish_Rep/FR19.pdf
- Northern Territory Government. (2012). Mud Crab Fishery. Fishery Status Reports 2011. NT Department of Resources. Fishery Report No. 111, pp. 63-72. http://www.nt.gov.au/d/Content/File/p/Fish_Rep/FR111.pdf
- Queensland Government. (2011). Annual Status Report 2011 – Mud Crab Fishery. Qld Department of Employment, Economic Development and Innovation, 14 pp.
http://www.dpi.qld.gov.au/documents/Fisheries_SustainableFishing/2011-MC-ASR-FINAL.pdf
- Richards, F. J. (1959). A flexible growth function for empirical use. *Journal of Experimental Biology*, **10**:290-300.
- Rudershausen, P. J., and Turano, M. J. (2009). The effect of cull rings on catch rates of blue crabs *Callinectes sapidus* in the North Carolina trap fishery. *North American Journal of Fisheries Management*, **29**:1152-1164.
- Stasko, A. B. (1975). Modified lobster traps for catching crabs and keeping lobsters out. *Journal of the Fisheries Research Board of Canada*, **32**:2515-2520.

Stevens, B. G. (1995). Crab bycatch in pot fisheries: causes and solutions. *In*: "Solving Bycatch: Considerations for Today and Tomorrow, Alaska Sea Grant College Program Report No. 96-03", University of Alaska Fairbanks, pp. 151-158.

Tallack, S. M. L. (2007). Escape ring selectivity, bycatch, and discard survivability in the New England fishery for deep-water red crab, *Chaceon quinque-dens*. *ICES Journal of Marine Science*, **64**:1579-1586.

Treble, R. J., Millar, R. B. and Walker, T. I. (1998). Size-selectivity of lobster pots with escape-gaps: application of the SELECT method to the southern rock lobster (*Jasus edwardsii*) fishery in Victoria, Australia. *Fisheries Research*, **34**: 289-305.

Varikul, V., Phumiphol, S. and Hongpromyart, M. (1972). Preliminary experiments in pond rearing and some biological studies of *Scylla serrata* (Forsk.). *In*: T. V. R Pillay (Ed.). "Coastal aquaculture in the Indo-Pacific region", pp. 366-374.

Ward, T. M. Schmarr, D. W. and McGarvey, R. (2008). Northern Territory Mud Crab Fishery: 2007 Stock Assessment. Report to the Northern Territory Department of Primary Industry, Fisheries and Mines. SARDI Research Report Series No. 244, 106 pp.

http://www.nt.gov.au/d/Content/File/p/Research/NT_Mud_Crab_2007.pdf

Water Quality and Aquatic Ecosystems Health, Environment and Resource Sciences. (2012). Moreton Bay Marine Park Monitoring 2012. Qld Department of Environment and Resource Management, 30029, 28 pp.

http://www.derm.qld.gov.au/parks_and_forests/marine_parks/moreton_bay_marine_park_zoning_plan_review/pdfs/moreton-marine-park-monitoring-report.pdf

West, L. D., Lyle, J. M., Matthews, S. R., Stark, K. E. and Steffe, A. S. (2012). A Survey of Recreational Fishing in the Northern Territory, 2009-10. NT Government Fishery Report No. 109, 125 pp.

http://www.nt.gov.au/d/Content/File/p/Fish_Rep/FR109.pdf

Xu, X., and Millar, R. B. (1993). Estimation of trap selectivity for male snow crab (*Chionoecetes opilio*) using the SELECT modelling approach with unequal sampling effort. *Canadian Journal of Fisheries and Aquatic Sciences*, **50**:2485-2490.

15 APPENDIX 1: INTELLECTUAL PROPERTY

There are no intellectual property and/or valuable information issues arising from this project. The work was conducted in the public domain for public good.

16 APPENDIX 2: STAFF

Table 16.1. Project staff and affiliations

Position	Name	Organisation
Principal Investigator	Mark Grubert	DPIF
Co-investigators	Ian Brown	Qld DAFF
	Danielle Johnston	WA Fisheries
	Ron Larsen	Crabmaster systems
	Hock Lee	DPIF
	Doug Neville	NT Mud Crab Fishery Licensee Committee
Project staff	Lee Abraham	DPIF
	Quentin Allsop	DPIF
	Wayne Baldwin	DPIF
	Alex Beatty	DPIF
	Matt Crookes	Volunteer
	Toni Crookes	DPIF
	Stephen Cusack	Larrakia Sea Rangers
	Kane Dysart	DPIF
	Chris Errity	DPIF
	Dan Firth	DPIF
	Andrew Gould	DPIF
	Andria Handley	DPIF
	Mark Hearnden	DPIF
	Grant Johnson	DPIF
	Patti Kuhl	DPIF
	Poncie Kurnoth	DPIF
	Emily Lawson	DPIF
	Adrian Ludwig	Larrakia Sea Rangers
	Jimmy Maher	DPIF
	Steve Matthews	DPIF
	Tom Noyce	Volunteer
	Thor Saunders	DPIF
	Graham Schultz	DPIF
	Trevor Schultz	Volunteer
	Trix Trojan	DPIF
Executive Officer	Bruce Young-Smith	DPIF

17 APPENDIX 3: PARAMETER ESTIMATES AND CORRELATION COEFFICIENTS (ADJUSTED r^2) FOR GAUSSIAN CURVES FITTED TO RELATIVE SIZE FREQUENCY DATA

Figure 17.1. Parameter estimates and correlation coefficients (Adjusted r^2) for Gaussian curves fitted to relative size frequency data. The basic form of the equations is $y = a_n^{-(x-b_n)/c_n)^2}$, with the right hand side of the equation repeated once or twice in those cases where there are two or three modes, respectively.

Figure	Plot	a_1	b_1	c_1	a_2	b_2	c_2	a_3	b_3	c_3	Adj. r^2
6.4	a	0.0941	144.6	30.79	-	-	-	-	-	-	0.853
	b	0.1587	148.0	16.07	-	-	-	-	-	-	0.910
7.4	a	0.1045	161.9	26.22	-	-	-	-	-	-	0.885
	b	0.1205	164.3	11.90	0.0409	144.0	33.92	-	-	-	0.976
7.5	a	0.0880	136.7	31.61	-	-	-	-	-	-	0.785
	b	0.2291	147.0	4.16	0.0864	116.8	18.82	-	-	-	0.886
8.4	a	0.1283	150.2	22.09	-	-	-	-	-	-	0.933
	b	-0.0901	139.8	9.75	0.1625	144.6	22.93	-	-	-	0.918
	c	0.0986	144.0	29.51	-	-	-	-	-	-	0.879
	d	0.1108	156.4	15.61	0.1100	127.7	8.53	-	-	-	0.905
	e	0.1587	148.0	16.07	-	-	-	-	-	-	0.905
	f	0.0941	144.7	30.82	-	-	-	-	-	-	0.839
8.6	a	0.0739	161.1	18.08	0.0446	123.5	34.17	-	-	-	0.974
	b	0.0699	125.5	17.22	0.0792	163.7	11.97	0.0540	96.85	12.05	0.906
	c	0.0921	139.2	30.59	-	-	-	-	-	-	0.946
	d	0.0897	147.4	8.47	0.0506	126.5	43.27	-	-	-	0.759
	e	0.0888	137.6	31.59	-	-	-	-	-	-	0.932
	f	0.0913	160.9	15.13	0.0635	123.2	21.34	-	-	-	0.929
	g	0.1505	145.1	18.28	-	-	-	-	-	-	0.989
	h	0.1480	155.8	12.52	0.0593	152.6	5.15	0.0494	126.5	13.07	0.992
8.7	a	0.1197	145.0	22.14	-	-	-	-	-	-	0.939
	b	0.1132	169.4	12.77	0.0368	149.5	38.16	-	-	-	0.949
	c	0.1368	142.3	18.69	-	-	-	-	-	-	0.911
	d	0.1122	166.6	13.43	0.0811	135.8	14.66	-	-	-	0.975
	e	0.1133	129.4	24.52	-	-	-	-	-	-	0.958
	f	0.0741	124.2	24.07	0.0768	163.6	12.18	-	-	-	0.917
8.11	a	0.1005	140.3	27.75	-	-	-	-	-	-	0.927
	b	-0.1920	150.4	15.39	0.2282	153.4	25.08	-	-	-	0.979
	c	0.1004	151.2	28.12	-	-	-	-	-	-	0.940
	d	0.1252	169.6	16.19	0.0548	129.8	13.63	-	-	-	0.970
	e	0.1087	166.4	25.88	-	-	-	-	-	-	0.942
	f	0.2095	159.0	24.5	-0.1700	152.1	14.02	-	-	-	0.958

18 APPENDIX 4: SUMMARY OF THE SAMPLING TIMETABLE FOR THE MUD CRAB DEPLETION AND TRAPPING WEB SURVEYS ON THE ADELAIDE AND WEARYAN RIVERS, NT

Table 18.1. Sampling intervals and sample sizes for mud crab depletion and trapping web surveys on the Adelaide and Wearyan rivers, NT. The term “unique crabs” refers to live, unparasitised, previously untagged *Scylla serrata* caught in 70 mm x 50 mm wire mesh pots.

River	Survey type	Start date	End date	Unique crabs
Adelaide	Depletion	03/05/2002	10/05/2002	82
	Web	05/05/2002	09/05/2002	29
	Depletion	01/07/2002	08/07/2002	78
	Web	02/07/2002	06/07/2002	18
	Depletion	30/07/2002	06/08/2002	40
	Web	31/07/2002	04/08/2002	9
	Depletion	08/05/2003	13/05/2003	50
	Web	09/05/2003	12/05/2003	7
	Depletion	19/07/2003	24/07/2003	29
	Depletion	18/09/2003	23/09/2003	22
				364
Wearyan	Depletion	20/05/2002	27/05/2002	178
	Web	22/05/2002	26/05/2002	283
	Depletion	16/06/2002	23/06/2002	168
	Web	25/08/2002	29/08/2002	93
	Depletion	25/08/2002	01/09/2002	177
	Web	25/08/2002	29/08/2002	97
	Depletion	24/05/2003	29/05/2003	21
	Web	26/05/2003	30/05/2003	38
	Depletion	21/06/2003	26/06/2003	30
	Web	22/06/2003	26/06/2003	46
	Web	03/08/2003	07/08/2003	56
				1187

19 APPENDIX 5: SUMMARY OF THE SAMPLING TIMETABLE FOR THE MUD CRAB COMPONENT OF THE QLD LTMP

Table 19.1. Sampling effort (as days within each sampling period and year) and sample sizes for *Scylla serrata* caught during monitoring trips to the Gulf of Carpentaria (GOC), far north, northern wet and northern dry regions of Qld

Region	Year	Sampling period	Duration (days)	Sample size
GOC	2000	May	9	233
	2001	May/Jun	8	286
	2002	Apr/May	9	133
	2003	May	7	137
	2004	May	9	191
	2005	May	8	209
	2006	May/Jun/Jul	6	199
	2008	May	5	100
	2009	May	5	89
				1577
Far North	2000	Jun	2	32
	2001	May	2	130
	2002	May	2	79
	2003	May	2	94
	2004	Jun	2	120
	2005	May	2	191
	2006	Jul	2	120
				766
Northern Wet	2000	Mar	3	95
	2001	Mar	3	244
	2002	Mar	3	147
	2003	Mar	4	137
	2004	Mar/Apr	4	184
	2005	Mar	4	241
	2006	Mar/Apr	4	211
	2008	Mar/Apr	4	134
	2009	Mar/Apr	3	82
				1475
Northern Dry	2000	Mar	1	264
	2001	Feb/Mar	2	138
	2002	Mar	2	282
	2003	Mar	2	194
	2004	Mar/Apr	2	121
	2005	Mar	2	218
	2006	Mar	2	349
	2008	Mar	2	264
	2009	Apr	3	153
				1983

Table 19.2. Sampling effort (as days within each sampling period and year) and sample sizes for *Scylla serrata* caught during monitoring trips to the Capricorn, Fraser-Burnett and Moreton Bay regions of Qld

Region	Year	Sampling period	Duration (days)	Sample size
Capricorn	2000	Apr	3	146
	2001	Feb	4	233
	2002	Feb	3	227
	2003	Feb	3	212
	2004	Feb	3	172
	2005	Feb	3	106
	2006	Jan/Apr	5	192
	2007	Feb/Mar/Apr	3	139
	2008	Feb/Apr	8	513
	2009	Feb/Apr	6	122
				2062
Fraser-Burnett	2000	Apr	1	78
	2001	Feb	4	327
	2002	Jan	2	312
	2003	Jan	3	270
	2004	Feb	3	229
	2005	Jan	3	283
	2006	Jan	3	117
	2008	Feb	2	144
	2009	Feb	2	139
				1899
Moreton Bay	2000	Mar	3	251
	2001	Feb	3	372
	2002	Jan	3	414
	2003	Jan	3	281
	2004	Feb	3	378
	2005	Jan	3	305
	2006	Jan	3	281
	2008	Feb	3	292
	2009	Feb	4	307
				2881

20 APPENDIX 6: SUMMARY OF THE SAMPLING TIMETABLE FOR THE MORETON BAY MONITORING PROGRAM

Table 20.1. Sampling effort (as days within each year and season) and sample sizes for *Scylla serrata* caught in areas open and closed to fishing (general use and green zones, respectively) in the Moreton Bay Monitoring Program, Qld

Status	Year	Sampling period	Duration (days)	Sample size	
General use zone	2008	Winter	8	87	
	2009	Summer	8	288	
		Winter	6	228	
	2010	Summer	8	439	
		Winter	10	295	
	2011	Summer	9	520	
		Winter	3	200	
	2012	Summer	3	138	
				55	2195
	New green zone	2009	Summer	1	114
Winter			7	191	
2010		Summer	9	415	
		Winter	10	348	
2011		Summer	10	458	
		Winter	3	367	
2012		Summer	3	241	
			43	2134	
Old green zone	2008	Winter	2	69	
	2009	Summer	3	131	
		Winter	2	84	
	2010	Summer	3	133	
		Winter	2	167	
	2011	Summer	3	128	
			15	712	

21 APPENDIX 7: DERIVATION OF CATCH STATISTICS FOR THE NT RECREATIONAL MUD CRAB FISHERY

The recent NT recreational fishing survey conducted by West et al. (2012) provides estimates of mud crab catch, harvest and release totals for NT residents as well as harvest and release totals only for visitors to the NT.

The statistics for residents, obtained through a diary survey, were annualised and scaled to the population. The statistics for visitors, obtained from boat ramp surveys (at Bynoe Harbour, Darwin Harbour, Dundee Beach, Leaders Creek and the Mary River) and accommodation surveys (near the Daly, McArthur and Roper rivers), were scaled to estimated visitor numbers, but were not annualised and only refer to the sampling period April to November 2009 because this interval represents around 98% of the annual visitor catch and effort in the NT (West et al., 2012).

Whilst the accommodation surveys captured fishing activity in the previous 24 hours, the boat ramp surveys were restricted to the hours of 9 am to 7 pm, which accounts for about 85% of the boat-based fishing effort on a given day, boats being by far the most popular fishing platform in the NT (West et al., 2012).

We constructed Table 21.1 from mud crab catch (where available), harvest and release statistics for mud crabs given in Table 7 and Appendices 17 to 31 of West et al. (2012). Totals for boat ramp data were scaled to daily (24 hr) fishing effort by multiplying by 1.176 (1/85%). Based on these data, the release fraction for the NT recreational mud crab fishery in 2009 was 37% ($30\,207 \div 81\,190$).

Table 21.1. Recreational catch, harvest and release statistics for mud crabs in the NT relative to fisher origin and survey type (derived from West et al., 2012)

Fisher origin and survey type	Location	Harvest	Release	Catch
Resident diary survey	All¹	30 382	14 253	44 634
	Bynoe Harbour	1851	863	2714
	Darwin Harbour	5303	3083	8386
	Dundee Beach	116	34	150
Visitor boat ramp survey	Leaders Creek	509	478	987
	Mary River	0	0	0
	Total for 7 am to 9 pm	7779	4458	12 237
	Scaled to 24 hr period²	9152	5245	14 396
	Daly River	378	0	378
Visitor accommodation survey	McArthur River	11 073	10 709	21 782
	Roper River	0	0	0
	Accommodation total³	11 451	10 709	22 160
	Sum¹⁺²⁺³	50 985	30 207	81 190

22 APPENDIX 8: SCHEMATICS FOR PLASTIC INJECTION MOULDED ESCAPE VENTS

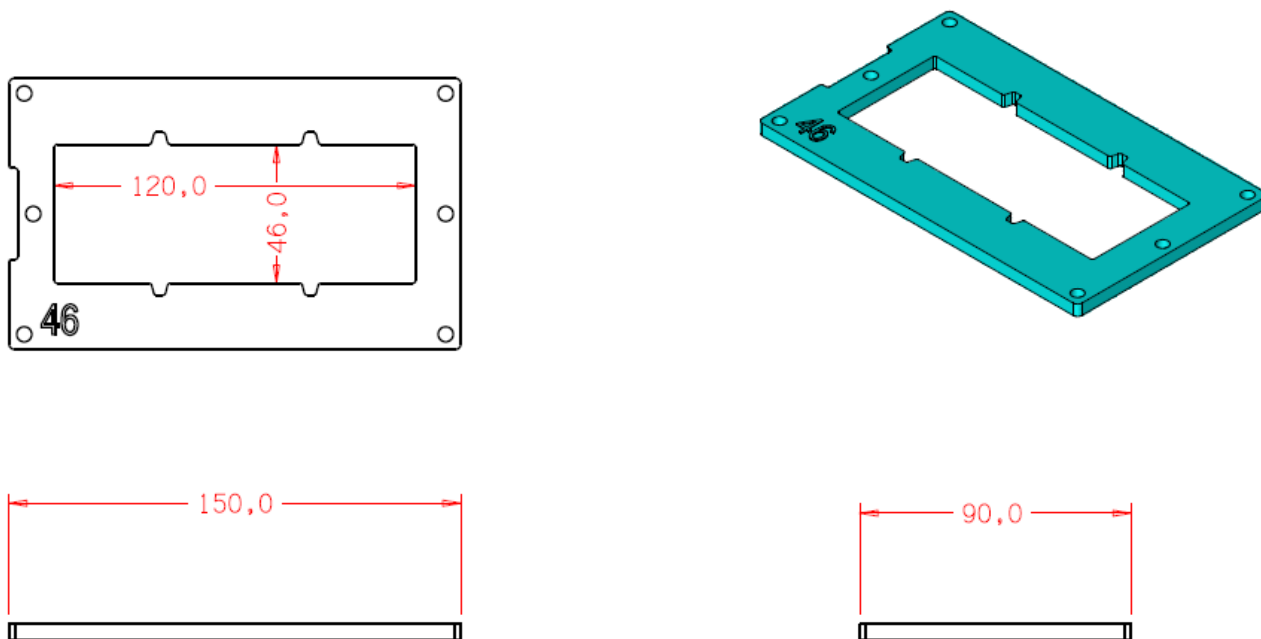

Figure 22.1. Schematics for 120 mm x 46 mm (W x H) escape vents (sized to retain *Scylla serrata* ≥ 140 mm carapace width) produced by Lincoln Plastics. Device thickness is 5 mm. The holes in the middle of the short edges have since been removed as they caused weak points. Likewise, the recess on the left side of the device has also been removed.

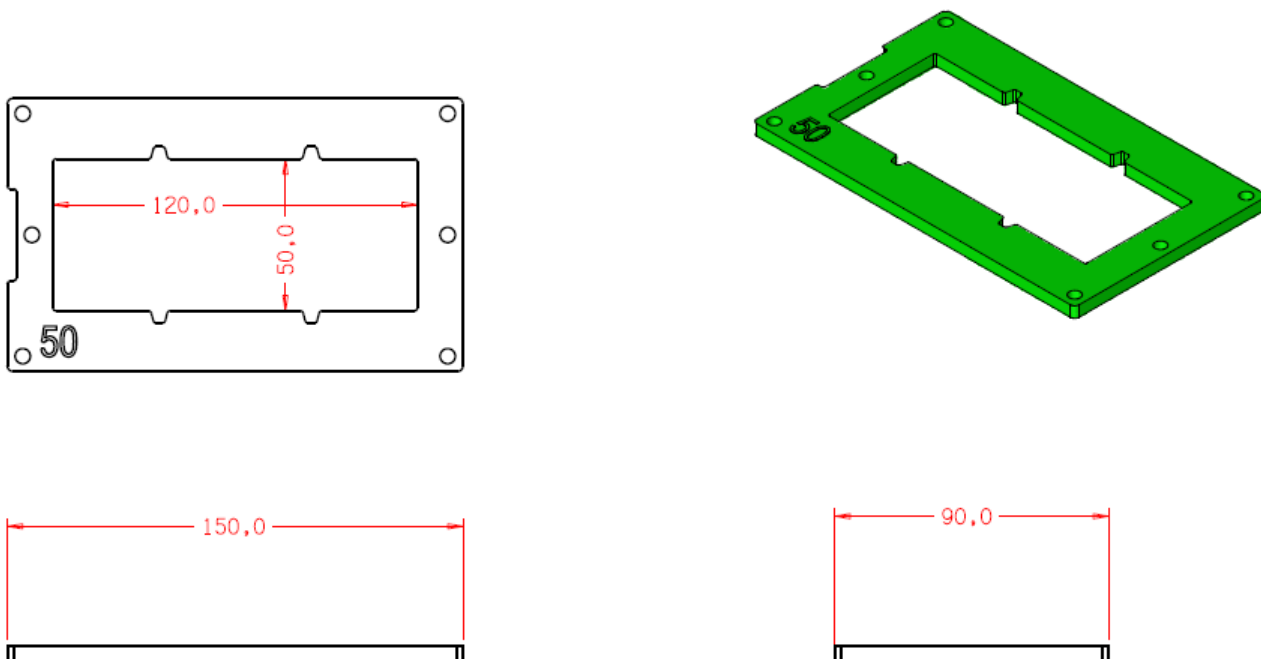

Figure 22.2. Schematics for 120 mm x 50 mm (W x H) escape vents (sized to retain *Scylla serrata* ≥ 150 mm carapace width) produced by Lincoln Plastics. Device thickness is 5 mm. The holes in the middle of the short edges have since been removed as they caused weak points. Likewise, the recess on the left side of the device has also been removed.

23 APPENDIX 9: PRESENTATIONS AND RELATED MEDIA

Presentations given to:

Qld DAFF fisheries management and research staff at Deception Bay, 12 May 2010.

Members of the public at Darwin BCF store, 23 October 2010.

DPIF staff at Berrimah Farm, 26 August 2011.

Delegates at the 6th World Fisheries Congress, Edinburgh, 11 May 2012.

Media reports/articles:

NT News, 11 June 2010: http://www.ntnews.com.au/article/2010/06/11/155091_ntnews.html.

Video footage on YouTube: <http://www.youtube.com/user/DoResources?feature=mhum>.

NT Seafood Council newsletter, June 2010: http://www.ntsc.com.au/newsletters/june2010_newsletter.pdf.

Escape with ET E-magazine; 2010.

North Australian Fishing and Outdoor Magazine; November 2010.

FRDC FISH Magazine; December 2010.

Interview with Liz Trevaskis, ABC local radio, Darwin, 3 May 2012;
<http://www.abc.net.au/rural/nt/content/201205/s3494892.htm>.